

Pressure transmitter with thin film technology

For mobile hydraulic applications

Model MH-1

WIKA data sheet PE 81.21

Applications

- Mobile hydraulics
- Machine building
- General industrial applications

Special features

- Measuring ranges from 0 ... 60 to 0 ... 600 bar
- Output signals 4 ... 20 mA and DC 1 ... 5 V
- Extremely shock and vibration resistant
- Ingress protection IP65 to IP69K (steam jet-proof)



Pressure transmitter, model MH-1

Description

Robust design

Extreme shock and vibration resistance, resistance to pressure spikes (CDS system) and ingress protection greater than IP68 make the model MH-1 pressure transmitter especially qualified for the harsh operating conditions in mobile hydraulics. Measuring ranges from 0 ... 60 to 0 ... 600 bar cover the standard applications in mobile hydraulics completely.

Proven thin-film sensor technology

The hermetically welded thin-film measuring cell ensures a high long-term leak tightness. The need for additional sealing materials is dispensed with completely.

The thin-film sensor is especially impressive in applications with high dynamic loads. The thin-film sensor of the MH-1 is made from stainless steel and is manufactured using sputtering technology which ensures a high long-term stability.

A special protection to prevent the escape of oil following damage is offered by the recessing of the security sensor within the process connection.

The design matched to mobile applications enables shock loading up to 100 g and vibration up to 20 g.

Very good EMC characteristics in accordance with EN 61326 ensure reliable operation even under severe EMC conditions. In addition, there is protection against load dump of up to 200 V.

High ingress protection

Even extreme temperature shocks do not affect the operational safety. Especially for mobile applications, these pressure transmitters offer a wide range of available ingress protections. As well as the M12 x 1 circular connector with a screw-on lid, an angular connector per DIN EN 175301-803, form C with IP65 is also available.

For extreme applications, cable versions up to IP69K (steam jet-proof) with pre-assembled, customer-specific connectors are available.

Measuring ranges

Gauge pressure						
bar	0 ... 60	0 ... 100	0 ... 160	0 ... 250	0 ... 400	0 ... 600
psi	0 ... 1,000	0 ... 1,500	0 ... 2,000	0 ... 3,000	0 ... 5,000	0 ... 8,000

Other measuring ranges on request.

Overload safety: 2 times

Vacuum tightness: Yes

Output signals

Signal type	Signal
Current (2-wire)	4 ... 20 mA
Voltage (3-wire)	DC 1 ... 5 V

Other output signals on request.

Load

- Current (2-wire): $\leq (\text{power supply} - 10 \text{ V}) / 0.02 \text{ A}$
- Voltage (3-wire): $> 5 \text{ k}\Omega$

Voltage supply

Power supply

- Current (2-wire): DC 10 ... 30 V
- Voltage (3-wire): DC 10 ... 30 V

Time response

Settling time: $\leq 5 \text{ ms}$

Reference conditions (per IEC 61298-1)

Temperature: 15 ... 25 °C (59 ... 77 °F)

Atmospheric pressure: 860 ... 1,060 mbar (12.5 ... 15.4 psi)

Humidity: 45 ... 75 % r. h.

Power supply: DC 24 V

Mounting position: Calibrated in vertical mounting position with process connection facing downwards.

Accuracy specifications

- Non-linearity (per IEC 61298-2): $\leq \pm 0.4 \%$ of span BFSL
- Accuracy $\leq 0.5 \%$ of span BFSL ¹⁾
- Long-term stability (per DIN 16086:2006-01): $\leq 0.2 \%$ of span/year

1) Including non-linearity, hysteresis, zero offset and end value deviation (corresponds to measured error per IEC 61298-2).

Operating conditions

Permissible temperature ranges

- Medium: -40 ... +125 °C (-40 ... +257 °F)
- Ambient: -30 ... +85 °C (-22 ... +185 °F), option: -40 ... +85 °C (-40 ... +185 °F)

Depending on the choice of sealing on the process connection, the electrical connection or cULus approval, the medium and ambient temperatures may be limited (for restrictions see "Process connections, sealings" and "Electrical connection").

Storage and transport conditions

Storage temperature: -40 ... +85 °C

Climate classes

- Storage: 1K4 (per EN 60721-3-1)
- Transport: 2K3 (per EN 60721-3-2)
- Operation: 4K4H (per EN 60721-3-4, without condensation or icing)

Vibration resistance: 20 g (IEC 60068-2-6)

Shock resistance: 500 g (IEC 60068-2-27)

Process connections

Standard	Thread size
DIN 3852-E	G ¼ A
	M14 x 1.5
ANSI/ASME B 12.5	¼ NPT

Others on request.

Electrical connections

Description	Ingress protection
Circular connector M12 x 1, 4-pin	IP67
Angular connector DIN 175301-803 C <ul style="list-style-type: none"> ■ Wire cross-section max. 0.75 mm² ■ Cable diameter 4.5 ... 6 mm 	IP65
Cable outlet (1.5 m, 3 m, 5 m) <ul style="list-style-type: none"> ■ Wire cross-section 3 x 0.75 mm² / AWG 20 with end splices ■ Cable diameter 5.9 mm (2-wire), 8.4 mm (3-wire) 	IP69K

Other connections on request.

Connection diagrams

Circular connector M12 x 1 (4-pin)			
		2-wire	3-wire
	U+	1	1
	U-	3	3
	S+	-	4

Angular connector DIN 175301-803 C			
		2-wire	3-wire
	U+	1	1
	U-	2	2
	S+	-	3

Cable outlet			
		2-wire	3-wire
	U+	brown	black
	U-	red	black
	S+	-	black

Electrical protective measures







- Short-circuit resistance: S+ vs. U-
- Reverse polarity protection: U+ vs. U-
- Insulation voltage: DC 500 V

Materials

Wetted parts

Stainless steel

Approvals

Logo	Description	Country
	EU declaration of conformity <ul style="list-style-type: none"> ■ EMC directive ■ Pressure equipment directive ■ RoHS directive 	European Union
	EAC <ul style="list-style-type: none"> ■ EMC directive ■ Pressure equipment directive 	Eurasian Economic Community
	GOST Metrology, measurement technology	Russia
	KazInMetr Metrology, measurement technology	Kazakhstan
-	MTSCHS Permission for commissioning	Kazakhstan
	BelGIM Metrology, measurement technology	Belarus
-	GPN Fire safety certification	Belarus
	UkrSEPRO Metrology, measurement technology	Ukraine
	Uzstandard Metrology, measurement technology	Uzbekistan
-	CPA Metrology, measurement technology	China
-	CRN Safety (e.g. electr. safety, overpressure, ...)	Canada

Manufacturer's information and certificates

Logo	Description
-	China RoHS conformity
-	MTTF > 100 years

Approvals and certificates, see website

Dimensions in mm (in)

with angular connector
DIN 175301-803 A

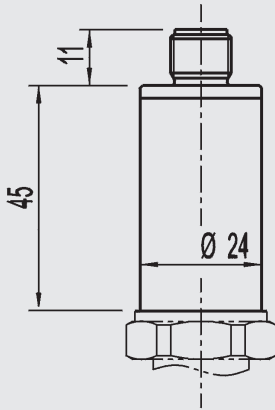

Weight approx. 0.2 kg

with M12 x 1 circular connector

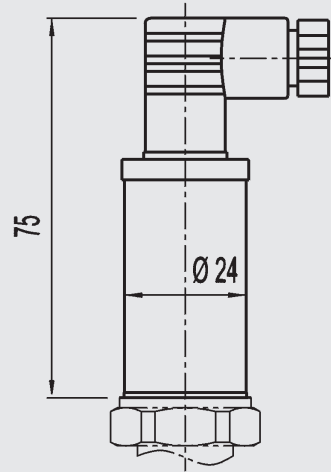

Weight approx. 0.2 kg

with cable outlet

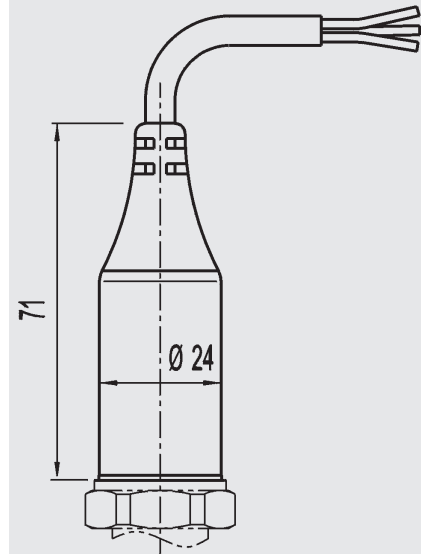

Weight approx. 0.2 kg

G 1/4 A DIN 3852-E
(overload safety 600 bar)

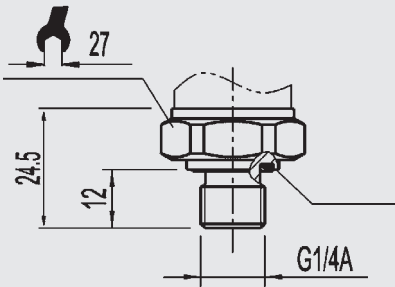

Pressure port \varnothing 3.5 mm

1/4 NPT

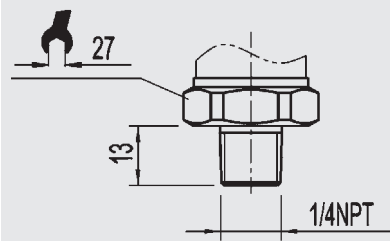

M14 x 1.5 DIN 3852-E
(overload safety 600 bar)

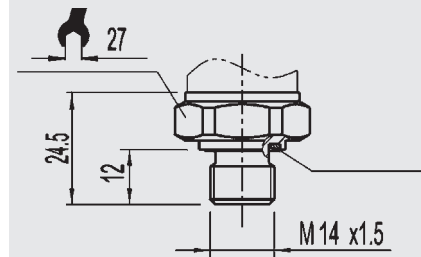

For information on tapped holes and welding sockets, see Technical information IN 00.14 at www.wika.com.

Accessories and spare parts

Mating connector

Description	Order number			
	without cable	2 m (6 ft) cable	5 m (16 ft) cable	2 m (6 ft) cable, shielded
Angular connector DIN EN 175301-803 C	1439081	11225823	11250194	-
Circular connector M12 x 1 (4-pin)				
■ straight	-	11250780	11250259	14056584
■ angled	-	11250798	11250232	-

Sealings for mating connectors

Mating connector	Order number	
	Blue (WIKA)	Brown (neutral)
Angular connector DIN EN 175301-803 C	11169479	11437881

Sealings for process connection

Thread size	Order number		
	NBR	FKM	FPM
G ¼ A	1537857	1576534	1576534
M14 x 1.5	1537857	1576534	-

Ordering information

Model / Measuring range / Output signal / Process connection / Sealing / Electrical connection / Ambient temperature range / Accessories and spare parts

© 09/1998 WIKA Alexander Wiegand SE & Co. KG, all rights reserved.
The specifications given in this document represent the state of engineering at the time of publishing.
We reserve the right to make modifications to the specifications and materials.



WIKAL Alexander Wiegand SE & Co. KG
Alexander-Wiegand-Straße 30
63911 Klingenberg/Germany
Tel. +49 9372 132-0
Fax +49 9372 132-406
info@wika.de
www.wika.de