



Pressure | Temperature | Level | Force | Flow

# Machine building: Applications & subsystems



Smart in sensing



Alexander Wiegand,  
Chairman and CEO, WIKA

## About us

As a family-run business acting globally, with 10,200 highly qualified employees, the WIKA group of companies is a worldwide leader in pressure and temperature measurement. The company also sets the standard in the measurement of level, force and flow, and in calibration technology.

Founded in 1946, WIKA is today a strong and reliable partner for all the requirements of industrial measurement technology, thanks to a broad portfolio of high-precision instruments and comprehensive services.

With manufacturing locations around the globe, WIKA ensures flexibility and the highest delivery performance. Every year, over 50 million quality products, both standard and customer-specific solutions, are delivered in batches of 1 to over 10,000 units.

With numerous wholly owned subsidiaries and partners, WIKA competently and reliably supports its customers worldwide. Our experienced engineers and sales experts are your competent and dependable contacts locally.

# Contents

|                                  |           |   |           |
|----------------------------------|-----------|---|-----------|
| <b>Your partner in all areas</b> | <b>03</b> | Plastics machinery                      | <b>32</b> |
| <b>Applications</b>              |           | Granulate preparation                   | <b>34</b> |
| <b>Machine tools</b>             | <b>06</b> | Temperature control units               | <b>36</b> |
| Hydraulic power packs            | <b>08</b> | High-pressure test benches              | <b>38</b> |
| Linear drives                    | <b>10</b> | Curing presses                          | <b>40</b> |
| Lubrication systems              | <b>12</b> | Cranes and hoists                       | <b>42</b> |
| Wind turbines                    | <b>14</b> | <b>General machine building</b>         | <b>44</b> |
| Screw compressors                | <b>16</b> | <b>Additional products and services</b> | <b>46</b> |
| Piston compressors               | <b>18</b> | Diaphragm seals                         | <b>46</b> |
| Pumps and systems                | <b>20</b> | Pressure sensor assemblies and modules  | <b>47</b> |
| Water-jet cutting                | <b>22</b> | Accessories                             | <b>48</b> |
| Tank level measurement           | <b>24</b> | Calibration technology and service      | <b>50</b> |
| Weighing technology              | <b>26</b> | Website and social media                | <b>54</b> |
| Filter systems                   | <b>28</b> | <b>WIKA worldwide</b>                   | <b>56</b> |
| Cooling lubricant systems        | <b>30</b> |   |           |

## WIKA – Your partner in all areas of machine building

WIKA supports companies in machine building with instrumentation solutions and services for pressure, temperature, level, force and flow measurement. Through many years of close cooperation with machine-building companies across a wide range of industrial sectors, the industry-specific challenges are well known to us.

Our measuring instruments can be ordered with a calibration certificate in accordance with the national accreditation. Over the entire service life of your machinery, we support you in the recalibration, maintenance and repair of your measuring equipment - close to the customer through our worldwide, nationally accredited DAkkS calibration laboratories.

In the breadth and depth of its range, WIKA offers an outstanding selection of measurement solutions. Thus component manufacturers and also machine and equipment builders always find the optimum solution for their specific demands within the following segments:

- Textile machinery
- Presses
- Filling and packaging machinery
- Paper machinery
- Printing machinery
- Transmissions
- Woodworking machinery
- Calibration benches





# Advantages of WIKA measuring instruments

## All relevant measurands in the portfolio

- indicating, switching or combined designs
- continuous measurement with analogue or digital output signals

## Easy to install

## Durable, even with high loads

- Shock and vibration
- Pressure spikes
- highly dynamic applications

## Maximum operational safety

- Shock and vibration
- Pressure spikes
- highly dynamic applications

## Reduced maintenance and repair effort

## High plant availability

# Time for networking

Wireless sensors are no longer simply suppliers of measured values.

Rather, the sensors can, in addition, be combined with extensive intelligence, so their performance is multiplied.

WIKa accompanies you through the 4th industrial revolution.



Industry 4.0 Cloud Digital transformation  
Smart Production Real-time data  
Edge computer Predictive maintenance  
Internet of Things





# International approvals

High-quality components are essential for safe and reliable production processes. The industrial instruments supplied by WIKA meet the guidelines and standards of the machine-building industry.

Rigorous testing of the instruments, by national and international certification bodies, results in reliability and stable workflows.

WIKA instruments create the prerequisites for highly efficient processes and the avoidance of risks to people, the environment and property, certified by a wide range of approvals and certificates from various industrialised nations and test authorities.

# CAD files for your plant planning

For many products, we offer CAD files (2D or 3D) in order to facilitate the integration of the instruments into your design. Various neutral and native formats guarantee compatibility with your individual planning software.

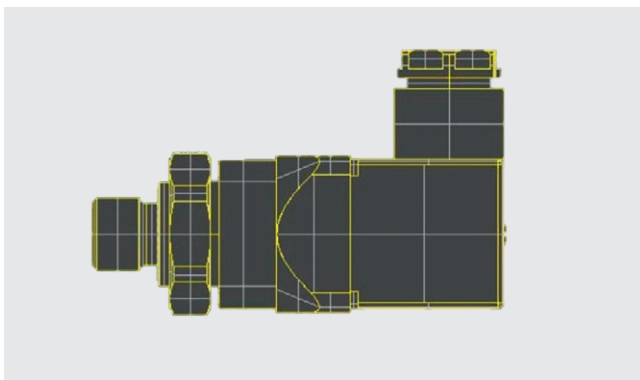

# Machine tools

This term combines turning, drilling and milling centres, presses, punches and also laser processing machines or high-pressure water-jet cutters. As metalworkers ourselves, WIKA knows the challenges of different machine tools from their own experience. The cooperation between development and their own premanufacturing has led to products which fulfil the measurement tasks of a machine tool outstandingly. Use the experience of WIKA for the selection of the right measuring instrument and its positioning.

Any machine tool, besides the machine itself, consists of the oil hydraulics (e.g. for the generation of the clamping pressure), the lubrication system for the lubrication of the bearings and drives as well as the cooling lubricant system for the tool cooling.

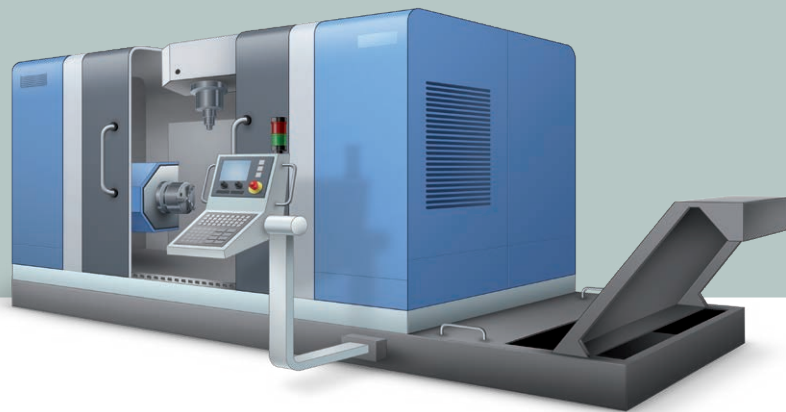

Our robust and accurate measuring instruments monitor the level in the cooling lubricant tank, the clamping force via the hydraulic pressure at the clamping cylinder, the spindle bearing temperature or also the closing force of a press. Our flow switch detects any insufficient flow of the cooling lubricant and thus protects the tool and workpiece from overheating and damage.

With presses, force is the main measured variable. In most cases, with hydraulically operated presses, the hydraulic pressure is measured and the force calculated from the piston area of the closing cylinder. A far more accurate result is provided by force transducers.

All measurands can be displayed at the measuring location, transmitted to the machine control with various standard signals or reported as a switch output on a limit value being exceeded.

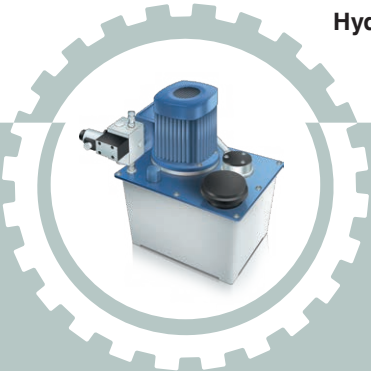

**Hydraulic power pack**  
see page 8

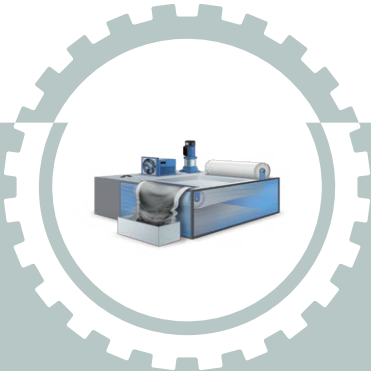

**Chip filter and cooling lubricant**, see pages 30 and 34

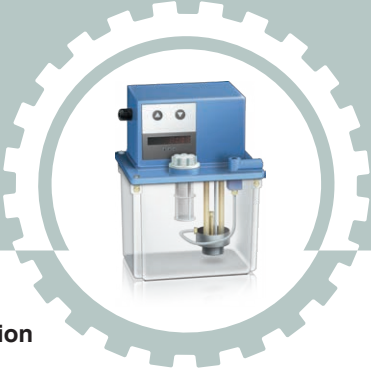

**Central lubrication**  
see page 12



# Hydraulic power packs

From fun-fair rides to workshop lifting platforms and also machine tools or plastics machinery – their operation always requires a hydraulic power pack. Only the high energy density of hydraulic machinery offers the highest forces at the lowest possible size.

The system pressure is read from a pressure gauge. Liquid-filled models are easily readable and unaffected by vibration.

The continuous recording and maintenance of the system and control pressures is monitored by pressure switches or sensors. The PSD-4 electronic pressure switch offers a combination of switching output, analogue output and an LED display which also offers good readability in dark mounting sites.

Mechanical damping of the pressure port protects the sensor element from pressure spikes.

The monitoring of the fill level in the hydraulic oil tank can signal oil deficiencies before the pump starts to suck in air.

With our temperature monitoring of the hydraulic oil, critical conditions can be identified early and the operational time for the oil can be extended.

Special requirements at the point of usage have been considered with our product development. For example, WIKA instruments work reliably in the gondola of a wind turbine and offer approvals for specific operating conditions or installation locations (e.g. ATEX).

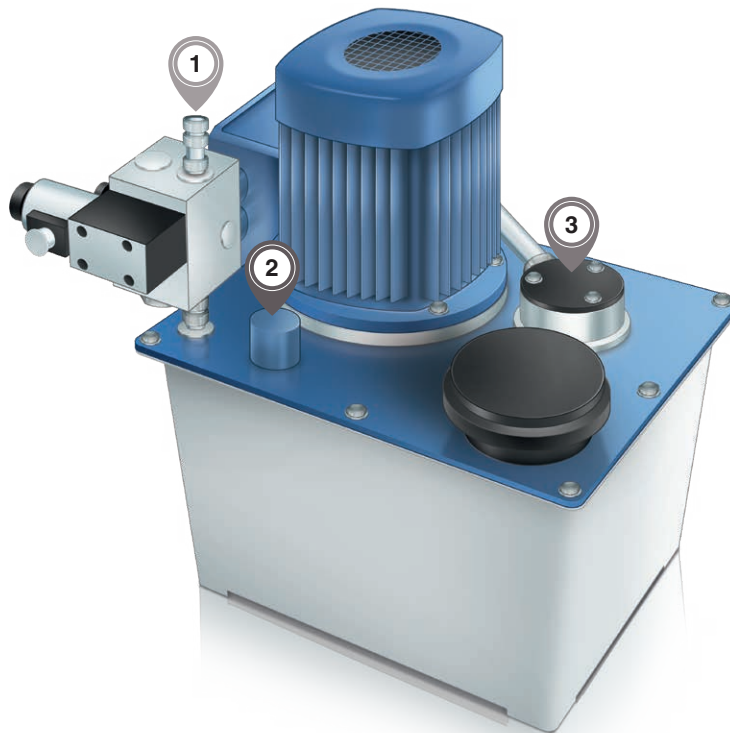

## Legend – Hydraulic power packs:

- ① System pressure – Pressure
- ② Oil level in the tank – Level
- ③ Temperature of hydraulic oil - Temperature

## Pressure

### Pressure sensors ①



A-10  
O-10  
M-10  
S-20  
IS-3  
A-1200

### Pressure gauges ①



111.10  
111.12  
113.53  
131.11  
213.53

### Pressure switches ①



PSD-4  
PSD-4-ECO  
PGT21  
PGT23



PSM01  
PSM02  
PSM-700

## Temperature

### Resistance thermometers ③



TR30  
TR33  
TF35  
TFT35

### Temperature switches ③



TFS35  
TFS135  
TSD-30

## Level

### Level switches ②



OLS-C01  
OLS-C02  
OLS-C51



RLS-1000  
RLS-3000

# Linear drives

To an increasing extent, hydraulically and pneumatically powered drive elements are getting replaced with a combination of electric motors and mechanical thrust units. Indirect force measurement via the control pressure is no longer possible here.

WIKA makes the integration of the (now necessary) direct force measurement into the drive chain particularly easy for you, from miniature transducers for often limited installation space to precision force sensors. For this, the sensor can be mounted on the motor, in the middle of the line or at the press-in point itself.

Industry 4.0 and IIoT also present themselves in force measurement, with the move from indicating measuring instruments to electronic sensors. A team of specialists is available for you for special solutions.

## Application examples:

- Measuring the axial force on electric friction presses to control the mating forces
- Monitoring of overload protection in lifting cylinders
- Force measurement in electromechanical servo spindle drives
- Force measurement on punches and presses
- Force measurement on welding tongs

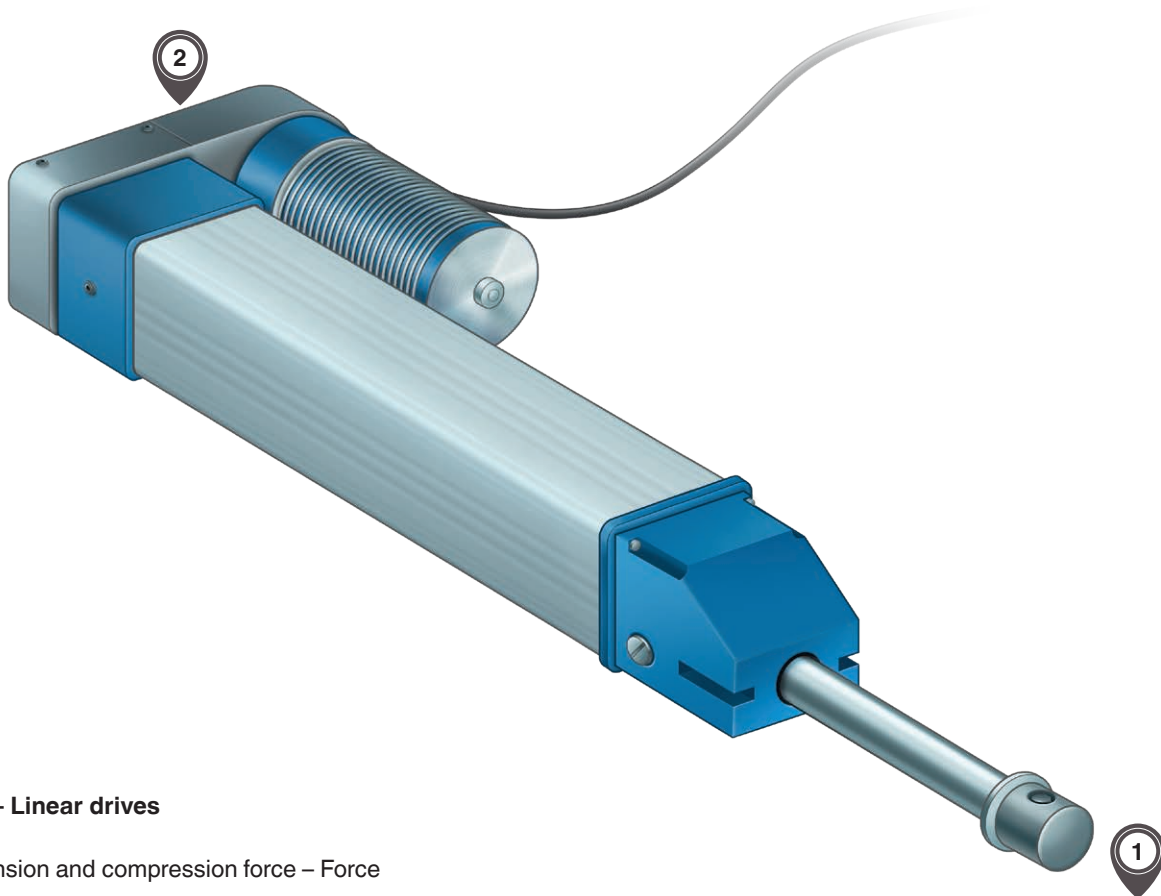

## Legend – Linear drives

- ① Tension and compression force – Force
- ② Tension and compression force – Force, integrated



## Force

### Tension/compression force transducers

①



F2301  
F2303  
F2304  
F23C1  
F23S1

### Miniature tension/compression force transducers

①



F2220  
F2221  
F2812  
F2808

### Ring force transducers

②



F6804  
F6212  
F6223



# Lubrication systems

Lubrication systems with lubricating grease or oil minimise friction and wear. They improve the machine reliability and service life of all moving parts and bearings, reducing corrosion and lowering downtime.

WIKA measurement technology enables lubrication with the right quantity at exactly the right point. For this, recording the system pressure is a basic prerequisite. To ensure that the desired quantity of the lubricant is actually provided – and that no outlets are blocked – it is advisable to install a flow measuring instrument.

Your advantage: The consumption is optimised and thus also lubricant costs and environmental compatibility.

The level monitoring in the reservoir ensures uninterrupted lubrication. This can be carried out through visual inspection or automatically – for example, if the reservoir is mounted out-of-sight – with a level sensor or switch.

If the lubrication system is exposed to wind and weather, low ambient temperatures can lead to a lubricant viscosity that is too high. Here, there should be heating of the reservoir. Its control uses the measuring signal of a temperature switch (monitoring of limit values) or a temperature probe (continuous temperature measurement). Our RLS-3000 float switch offers the special feature of level and temperature measurement combined into a single instrument.

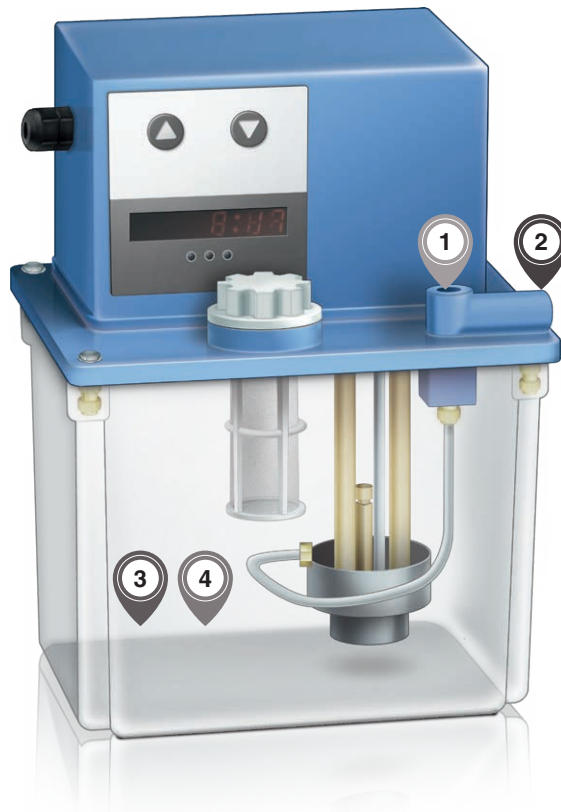

## Legend – Lubrication systems:

- ① Connection of the lubrication system – Pressure
- ② Monitoring of the supply of the lubrication points – Flow
- ③ Level of the reservoir – Level
- ④ Temperature of the lubricant – Temperature

## Pressure

### Pressure sensors ①



A-10  
O-10  
A-1200

### Pressure gauges ①



111.10  
111.12  
131.11  
113.53  
213.53  
PGT21

### Pressure switches ①



PSM01  
PSM02  
PSM-700

## Temperature

### Resistance thermometers ④



TR10-C  
TR30  
TR31  
TR33  
TFT35  
TF35

### Dial thermometers ④



TG54  
A52

### Temperature switches ④



TFS35  
TSD-30

## Level

### Level switches ③



OLS-C01  
OLS-C02  
RLS-1000  
RLS-3000

## Flow

### Flow switches ②



FSD-4  
FSM-6100



# Wind turbines

All moving parts of a windmill require reliable lubrication. The lubricant pressure is monitored by sensors or pressure switches, as well as the level and temperature.

The rotor blade adjustment and the alignment of the nacelle to the wind, but also safety functions such as the disc brakes or the maintenance bolts, are carried out hydraulically, driven by a hydraulic power pack (see page 10).

Despite often very low temperatures at the head of the wind power plant, the waste heat, e.g. of the generator and power electronics, requires air conditioning. WIKA offers suitable sensors for measuring the room temperature and for operating the refrigeration units.

Gas-based fire suppression systems suppress any fire occurring. For this, pressure gauges or pressure switches ensure that the extinguishing system is ready for use, they monitor the pressure in the gas cylinders and report any critical pressure drops.

Thanks to their modular structure, windmills have numerous threaded connections that can be loosened by the strong vibrations. To monitor the tightening torques, WIKA has developed ring force transducers that are installed between the screw head and the support.

Mechanically, the rotor blades are very stressed. Strain transducers can detect material changes at an early stage.

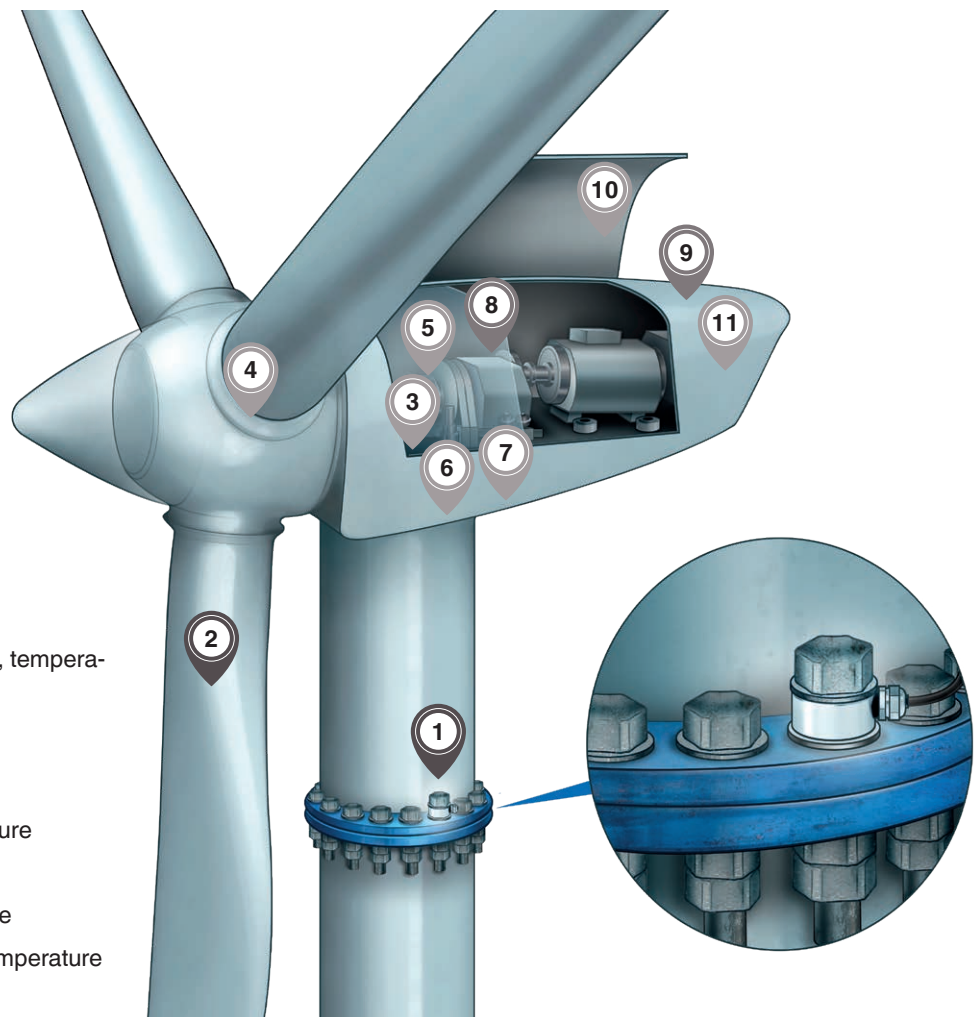

## Legend – Wind power plants:

- ① Ring force transducer – Force
- ② Strain transducer – Force
- ③ Hydraulic power pack – Pressure, temperature, level
- ④ Blade adjustment – Pressure
- ⑤ Rotor brake – Pressure
- ⑥ Wind direction alignment – Pressure
- ⑦ Lubrication – Pressure
- ⑧ Transmission – Level, temperature
- ⑨ Temperature control/cooling – Temperature
- ⑩ Service crane – Pressure, force
- ⑪ CO<sub>2</sub> fire-extinguishing system – Pressure

## Pressure

### Pressure sensors

3 4 5 6 7 10



O-10  
A-10  
S-20  
A-1200  
R-1

### Pressure gauges

3 4 5 6 7 10 11



111.10  
111.12  
113.53  
131.11  
213.53

### Pressure switches

3 4 5 6 7 10 11



PSM01  
PSM02  
PSD-4  
PSD-4-ECO  
PXS  
PGS21

## Temperature

### Resistance thermometers

3 8 9



TR30  
TFT35

### Temperature switches

3 8 9



TFS35  
TFS135  
TSD-30

### Resistance thermometers

9

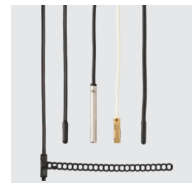

TF43

## Level

### Level switches

3



RLS-1000  
RLS-3000  
OLS-C01  
OLS-C02

### Level sensors

3



RLT-1000  
RLT-3000

## Force

### Inclination sensor

1 2 10



N1101

## Force

### Ring force transducers

1 2 10



F6137  
F6148  
F6160  
F6171  
F6215  
F9302

### Load pins

1 2 10



F5301  
F53S8  
F5308  
FRKPS

# Screw compressors

Screw compressors are the most widely used compressor design in the industry. They supply compressed air continuously, are very well controllable, extremely efficient and quiet (occupational safety, environmental protection, noise emission). There are versions with different numbers of stages, various cooling and lubricating processes or drive types.

The most common model is the single-stage, oil-lubricated rotating screw compressor. Wherever even the lowest quantities of oil in the compressed air would contaminate the product or the process, oil-free compressors are used.

At the air inlet and the compressed air outlet, pressure and temperature are measured. For this, both pressure gauges/thermometers for direct display, and also pressure sensors/resistance thermometers with Pt100 or PTC sensors are standard instrumentation. In addition, pressures and differential pressures at the suction filter and at the oil reservoir/filter are monitored.

Further temperature measuring locations are found at the oil cooler or in the area of compressed air preparation (e.g. filter dryer). Furthermore, our measuring instruments also reliably monitor the pressure and the level in the compressed air tank.



## Legend – Screw compressors:

- |  |   |
|--|---|
| ① Air inlet – Pressure                         | ⑤ Compressed air tank – Pressure            |
| ② Air inlet – Temperature                      | ⑥ Condensate in compressed air tank – Level |
| ③ Outlet of the compressor stage – Pressure    | ⑦ Compressed air outlet – Pressure          |
| ④ Outlet of the compressor stage – Temperature | ⑧ Compressed air outlet – Temperature       |

## Pressure

### Pressure sensors

① ③ ⑤ ⑦



O-10

### Pressure gauges

① ③ ⑤ ⑦



111.10  
111.12  
213.53  
PGT21

### Pressure switches

⑤



PSM-520  
PSD-4  
PSD-4-ECO

## Temperature

### Resistance thermometers

② ④ ⑧



TF35  
TF37  
TF45  
TFT35  
TR33

### Thermometers with switch contacts

② ④ ⑧

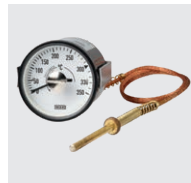

SB15  
SC15

### Temperature switches

② ④ ⑧



TFS35  
TFS135

## Level

### Optoelectronic switches

⑥



OLS-C01  
OLS-C02  
OLS-C05

### Magnetic float switches

⑥



HLS-M  
RLS-8000

### Float switches

⑥



RLS-1000  
RLS-3000

### Continuous measurement

⑥



RLT-1000  
RLT-3000

# Piston compressors

Piston compressors are 1-, 2-, 3- or 4-cylinder versions, corresponding to the compressed air demand or the level of pressure required of them. With a 2-cylinder compressor as “parallel switching”, the generated air volume is doubled. In “series switching”, where the output of the first cylinder is connected to the input of the second cylinder, higher system pressures are achieved.

A piston compressor consists of a crankshaft, a connecting rod, a cylinder and piston and a valve head. The crankshaft is driven via a V-belt, usually by an electric motor.

There are small models which only consist of a motor with cylinder/piston. However, most compressors have a compressed air tank, in order to maintain a stable system pressure to the compressed air consumer.

The operation of compressed air tools leads to dropping pressure in the tank. When the pressure drops below the lower limit, the motor starts; when the upper limit is exceeded, the motor automatically switches off. Pressure switches ensure a stable system pressure within the set limits (switch points).

The pressure in the tank, so the available operating pressure, and thus also the function of the On/Off switch, is reliably indicated by the WIKA pressure gauge.

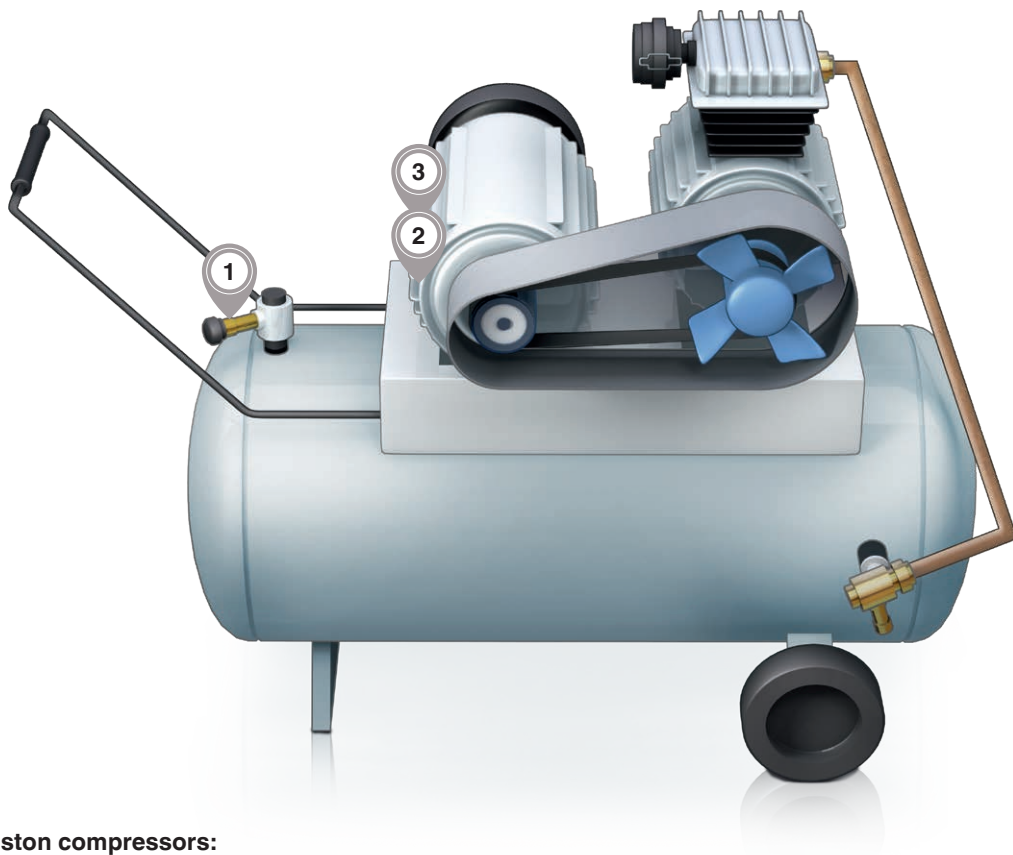

## Legend – Piston compressors:

- ① Compressed air tank – Pressure
- ② Working air – Pressure
- ③ Compressed air input in the tank – Pressure

Pressure

Pressure gauges

1 2



111.10  
111.12  
213.53

Pressure switches

3



PSM01  
PSM02

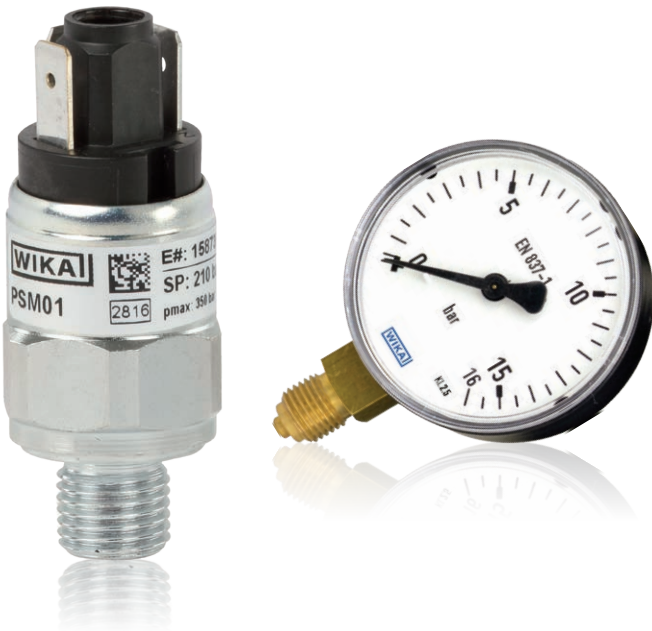



# Pumps and systems

The first pumps ensured the supply of drinking water to people, thus increasing the quality of life. Today, pumps supply the widest range of media in many processes and designs. The safe monitoring and automatic control of output pressures and delivery volumes is important. Specially for these measuring tasks, WIKA offers the right portfolio for each application and each pump.

Our pressure switches protect centrifugal pumps with insufficient input pressure against dry running.

Pressure sensors measure the pressure at the output and allow a constant system pressure through energy-efficient speed control. They detect pressure rises when running against a closed valve or gate, thus protecting the pump.

Diaphragm pumps are frequently used with aggressive or toxic media. Here, reliable diaphragm monitoring by pressure switches or process transmitters ensures the protection of people and the environment.

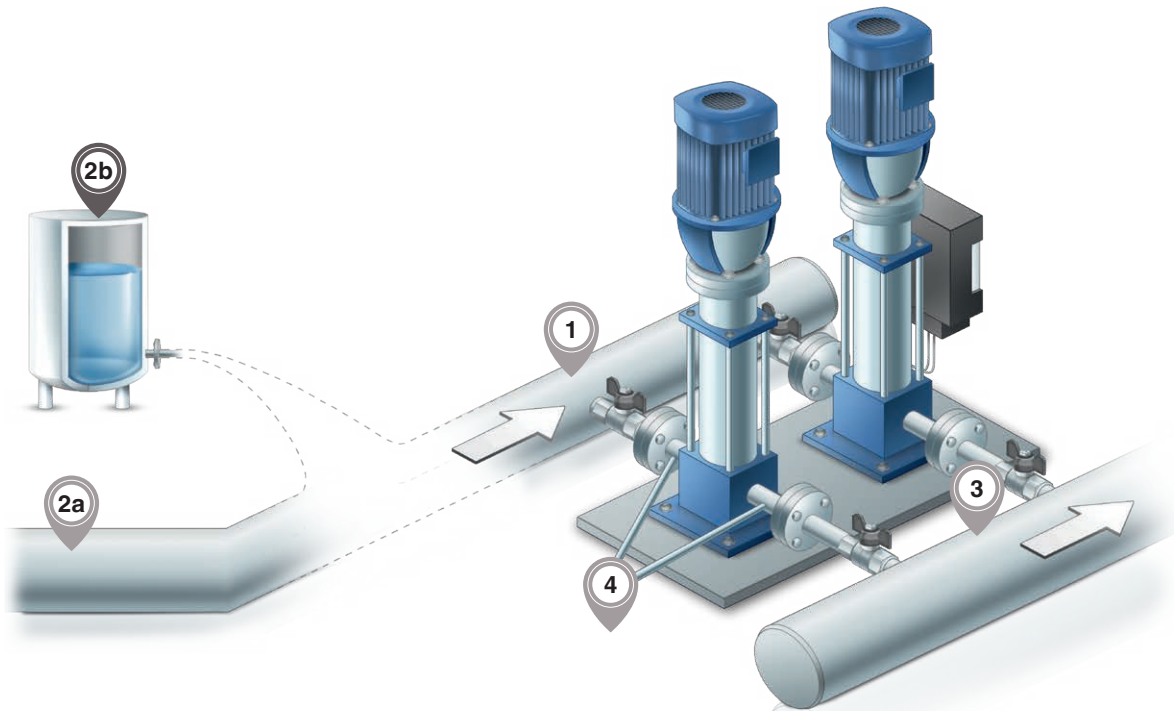

## Legend – Pumps and systems:

- ① Input pressure – Pressure
- ②a Dry run protection – Pressure
- ②b Dry run protection – Level
- ③ Output pressure – Pressure
- ④ Pump performance – Differential pressure

## Pressure

### Pressure sensors

3



A-10  
IS-3  
O-10

### Pressure gauges

1 3



113.53  
131.11  
213.53  
232.50  
233.50

### Pressure switches

2a 3



PSM-520  
PSD-4  
PSD-4-ECO



PSM01  
PSM02

## Level

### Submersible pressure sensors

2b



LS-10  
LF-1

### Level switches

2b



OLS-C01  
OLS-C02



RLS-1000  
RLS-2000  
RLS-3000  
RLS-6000

## Force

### Load cells

2b



F3201  
F3831  
F3203  
F3833  
F9302  
F1861

# Water-jet cutting

Water-jet cutting is used in many sectors of industry and the materials to be processed are almost unlimited: Metal, stone, glass, composite materials or even food.

Cutting with water pressure offers advantages over plasma cutting or laser cutting.

- It does not introduce any heat into the material, so there is no structural change.
- The edges are so precise that post-processing is usually unnecessary.
- The gap width is only small.
- The shapes of the cutting contours are almost unlimited.

In addition, there are no tooling costs for water-jet cutting, in contrast to machining with a punch.

In abrasive water-jet cutting, an abrasive is added to the coherent high-pressure water jet. Modern water-jet cutting systems work with up to 6,000 bar water pressure and the jet leaves the cutting nozzle at 3 times the speed of sound.

To protect the pump from cavitation and dry running, an adequate water flow is required. WIKA has the right switches both for monitoring the input pressure and also for temperature monitoring.

For level monitoring of the peripheral abrasive reservoir, weighing offers the advantage that the external measurement technology is not affected by contamination from the abrasive dust in the vessel.

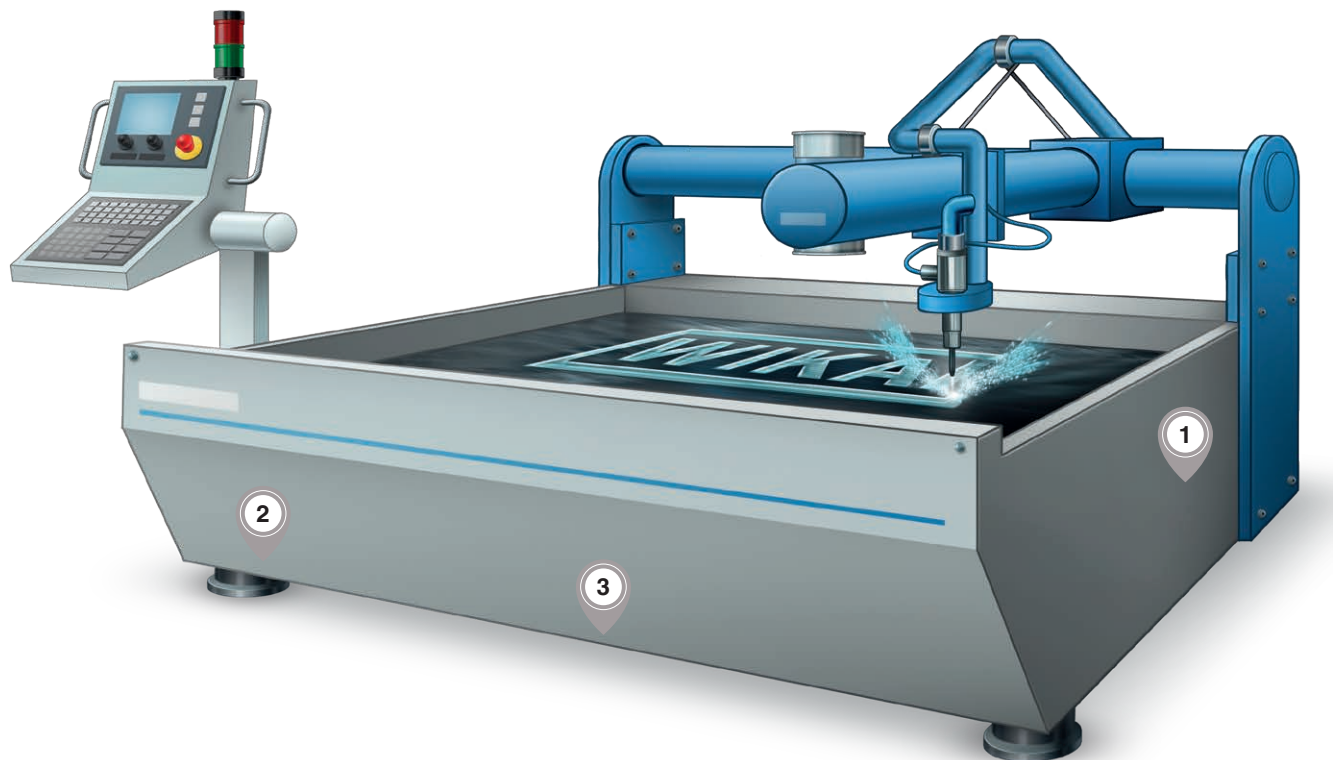

## Legend – Water-jet cutting:

- ① Water intake – Pressure
- ② High-pressure pump – Pressure, temperature
- or
- ③ Hydraulics and pressure booster – Pressure, temperature, level

## Pressure

### Pressure switches ①



PSM-520  
PSM02

### Pressure sensors ② ③



HP-2  
S-20  
A-10  
A-1200

### Pressure gauges ② ③



213.53  
23x.30  
23x.50  
PG23HP-P  
PG23HP-S

## Temperature

### Resistance thermometers ③



TF35  
TFT35  
TR10-D  
TR33

### Temperature switches ③



TSD-30  
TFS35

## Level

### Float switches and sensors ③



RLS-1000  
RLT-1000  
RLS-3000  
RLT-3000

## Force

### Load cells



F3201  
F3831  
F3203  
F3833  
F9302  
F1861

## Flow

### Flow switches



FSM-6100

## Accessories

### Valves



HPNV  
BV



# Tank level measurement

Whenever liquid media circulate from and into a storage tank in the circuit, for example the cooling lubricant of a machine tool or when liquids are conveyed from a tank or delivered into a tank, the filling height in the tank is a relevant control variable.

This can be designed as a simple on/off control of the pump using a float switch or an optoelectronic level switch. Frequently, a continuously measuring submersible pressure sensor (hydrostatic pressure of the liquid column in the tank) is also used to operate an energy-efficient speed-controlled pump.

For all installations, the customer requires a “fit and forget” solution. The plant must function 100 % reliably, resistant against the widest variety of media and insensitive to solids. Of course this also applies to float switches and submersible pressure sensors.

Free-standing tanks offer a non-invasive way of monitoring - weighing the tank with contents.

The advantages of this weighing technology are

- no requirement to open the tank
- No media contact of the sensors
- independent of the type and nature of the medium in the tank (liquid/solid, conductive, temperature, ...)
- unaffected by vessel geometry

This weighing technology is also available as a verifiable system (OIML).

The pictured example of a sewage lifting system shows the challenging task of maintenance-free level measurement with an extremely solids-laden medium.

Here WIKA, in close cooperation with our customers, has developed a solution with unique reliability.

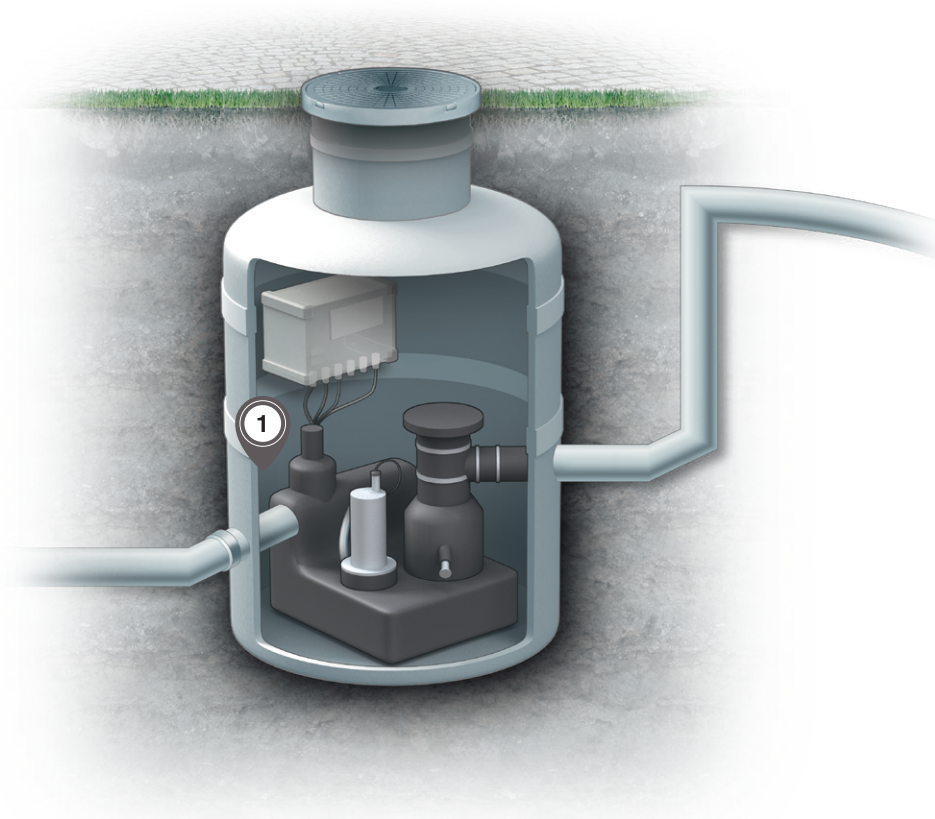

**Legend – Tank level measurement:**

① Level

## Pressure

### Pressure sensors



A-10  
S-11

## Force

### Load cells



F1861  
F3201  
F3203  
F3831  
F3833  
F9302

## Level

### Submersible pressure sensors



LS-10  
LF-1

### Optoelectronic switches



OLS-C01  
OLS-C02

### Bypass



BNA

### Float switches



RLS-1000  
RLS-2000  
RLS-3000  
RLS-4000  
RLS-6000  
RLS-7000



HLS-M  
RLS-8000

### Continuous measurement



RLT-1000  
RLT-2000  
RLT-3000





# Weighing technology

Load cells are designed as a special form of force sensor for use in weighing devices, such as in platform, filling, belt and packaging scales, dynamic test systems and also electronic price labelling and industrial scales. These load cells are very easy to integrate and enable very high measurement accuracies of between 0.01 % and 0.05 %  $F_{nom}$ .

For the different requirements, WIKA has all the typical load cell geometries within its portfolio. For these, there are, naturally, matching mounting kits as well as complete weighing modules also available.

A typical application are batch processes, with which different proportions of different components are dosed from

silos (for example, fodder silos) and later mixed. On a smaller scale, there are comparable processes in multi-head mixers.

The highly accurate and very stable WIKA load cells enable the portions to be dosed quickly and precisely. A special feature of our load cells is their insensitivity to transverse forces.

Compared to methods such as ultrasound or radar, weight measurement determines the mass of the container contents directly.

This eliminates the need to convert volume into mass - the measured value is more accurate.



## Legend – Weighing technology:

- ① Weight force measurement – Force

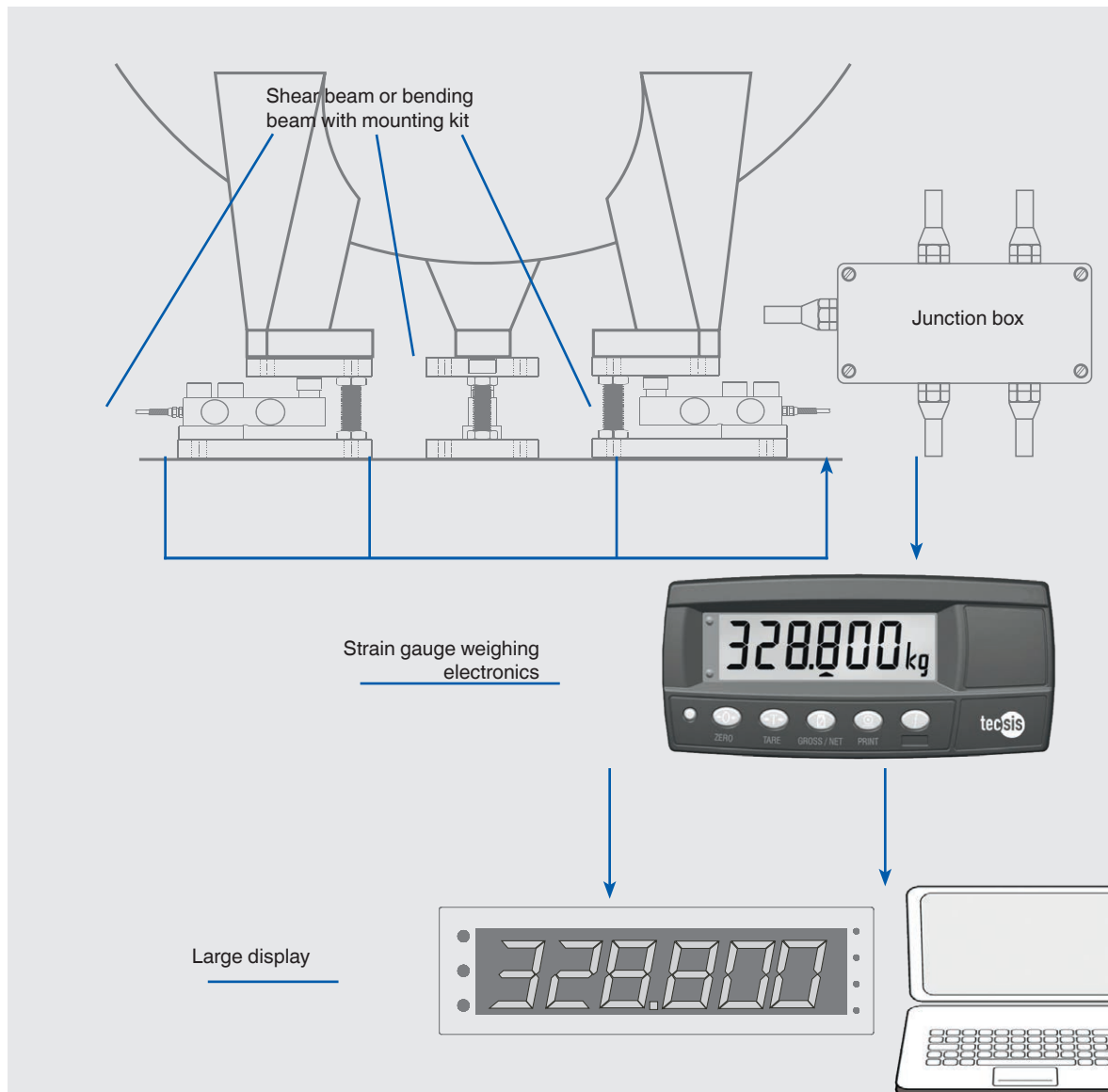

## Force

### Load cells



F4801  
F4802  
F4818

### Bending beams/shear beams



F3831  
F3201  
F33C1  
F32S1  
F3833  
F3203

### Tension/compression force transducers



F2802  
F2808

## Force

### Special force transducers



F1861  
F9302

### Electronics



E1930  
E1931  
E1932



# Filter systems

The usage of filters is as diverse as the requirements for their monitoring. The filter of a ventilation system, whose contamination produces a differential pressure of a few millibars, requires different instrumentation than a cartridge filter for oil hydraulics.

The reliability of WIKA pressure measuring instruments enables the efficient and interference-free operation of the plant. Your advantage: The energy consumption is optimised and thus also operating costs and environmental compatibility.

## Hydraulic filter application

Particles in hydraulic oil lead to a markedly higher wear of all moving parts, such as hydraulic pumps and motors, valve pistons or in the cylinder. Therefore, one or more filters in the circuit are among the most important components.

Installation is often in the return line to the tank, where the pressure level is low and the discharge is made against atmospheric pressure. Here a gauge pressure transmitter monitors the filter contamination.

If one wants to protect specific components such as the hydraulic motor, then the filter must be fitted in front of these components. For the monitoring of these, one requires differential pressure measurement – measurement of the pressure drop (the contamination) across the filter.

## Machine tool application

In addition to its actual task, the cooling lubricant helps to remove the chips produced.

The chip separator separates the solid chips from the liquid cooling lubricant so that it can be returned to the circuit.

A common problem is chip deposits on the float switch that controls the onward transport of the belt filter. This leads to an overflow of the cutting fluid, with corresponding effort in the cleaning of the hall - and also the risk of accidents due to the slippery floor.

One solution can be to measure the axial tension of the filter web or to weigh the chip pre-separator.

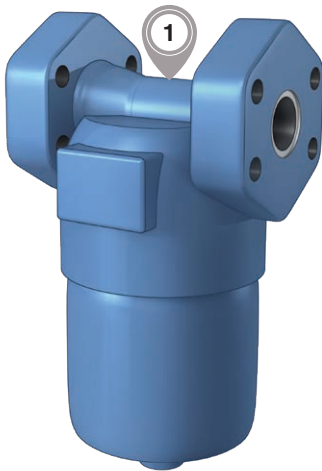

## Legend – Hydraulic filter/machine tool:

- ① Contamination of the filter – Pressure
- ② Contamination of the filter – Level (backing up of cooling lubricant)

## Pressure

### Pressure sensors ①



A-10  
S-20  
A-1200

### Pressure gauges ①



111.10  
111.12  
213.53  
113.53  
DPS40  
DPGS40

### Pressure switches ①



PSD-4  
PSD-4-ECO  
PSM02

### Differential pressure ①



700.01  
700.02  
A2G-05

## Level

### Level switches ②



RLT-1000  
RLS-1000  
RLS-6000  
HLS-M

## Force

### Bending beams/shear beams ②



F3201  
F3831  
F3203  
F3833  
F5301



# Cooling lubricant systems

When machining, the cooling lubricant emulsion fulfils three important functions in a machine tool: It lubricates at the machining point, cools the tool (drill, cutter) and supports the chip removal.

The system consists of the components

- Chip conveyor
- Chip filter
- Tank/pump unit

Evaporation, depletion through build-up on the chips and the introduction of foreign oils change the level in the tank and the concentration in use.

The level control, the refilling and the documentation can occupy a full-time employee in larger metalworking companies. Automation of these activities fulfils the requirements of TRGS 611 and brings further advantages in the spirit of Industry 4.0, such as the prompt detection of leaks due to conspicuous loss of cooling lubricant or the impending “tipping” of the cooling lubricant. It can be counteracted at an early stage and saves having to replace the cooling lubricant.

An alternative to float switches is the measurement of the axial tension by force sensors that detect the change in weight due to the filtered chips.



## Legend – Cooling lubricant system:

- ① Level in the tank – Level
- ② Temperature of the cooling lubricant – Temperature
- ③ Transport of the cooling lubricant – Pressure
- ④ Contamination of the filter – Level (backing up of cooling lubricant)

## Pressure

### Pressure sensors ④



A-10  
S-11  
A-1200

### Pressure gauges ④



111.10  
111.12  
113.53  
131.11  
213.53

### Pressure switches ④



PSD-4  
PSD-4-ECO  
PSM02

## Temperature

### Resistance thermometers ③



TR10-C  
TF35  
TFT35

### Dial thermometers ③



A52  
32

### Temperature switches ③



TFS35  
TSD-30

## Level

### Floats ① ⑤



RLS-1000  
RLS-3000  
RLS-6000  
RLS-8000  
HLS-M

## Flow

### Flow switches ④



FSM-6100

## Force

### Load cells ②



F3201  
F3831  
F3203  
F3833  
F5301



# Plastics machinery

As diverse as the products they manufacture are the designs of plastics machinery.

A blown-film machine for the production of barrier films, breathable films or adhesive tapes looks completely different from an injection moulding machine for the production of children's toys, parts for cases, transparent headlamp covers or medical components.

The common feature is the processing of plastic granulate, melting it and forming it. For this purpose, all machines have an extruder screw with heating collars in which the pellets are heated to a melt and which generates the necessary pressure at the outlet.

The precise maintenance of the melt temperature is an important precondition for product quality.

On the one hand, there must be the ability to flow, so that the injection mould can be filled completely and quickly, on the other hand, if the temperature is exceeded, the plastic material is damaged.

In addition to the injection moulding machine, every injection moulding process requires upstream granulate preparation (see following page). In the machine, subsystems (oil hydraulics and lubrication) ensure operational safety. The exact mould temperature is essential for the quality of the products produced. This is kept stable through one or more external temperature control units (see page 38). In each of these modules and systems, precise, robust and extremely reliable WIKA measuring instruments help to produce high-quality plastic products.



## Legend – Plastics machinery:

- ① System pressure - Pressure Oil level in tank - Level
- ② Temperature of hydraulic oil - Temperature
- ③ Temperature of the granulate melt - Temperature
- ④ Temperature at the injection mould - Temperature
- ⑤ Closing force on the injection mould – Force

## Pressure

### Pressure sensors ①



A-10  
A-1200  
S-20  
O-10  
M-10

### Pressure gauges ①



111.10  
111.12  
213.53

### Pressure switches ①



PSD-4  
PSD-4-ECO  
PSM02

## Temperature

### Resistance thermometers ③



TF35  
TF37  
TR10-B  
TR10-C  
TR10-D  
TR10-H  
TR33

### Temperature switches ③



TF35  
TFS35  
TSD-30

### Thermocouples ④ ⑤



TC46  
TC47-NT  
TC47-MT  
TC47-RL  
TC53

## Level

### Floats ②



RLS-1000  
RLS-3000  
OLS-C01

### Level switches ②



RLT-1000  
RLT-3000

## Force

### Ring force transducers ⑥



F6804  
F6212  
F6215  
F6223

# Granulate preparation

The drying and dedusting on the granules is a basic precondition for the manufacturing of superior plastic parts.

Due to product abrasion, many plastic granules already contain dust and fibres (angel hair) when delivered. These cause a reduction in quality in the end product, especially in optical and high-gloss parts, or it can lead to plant downtime through product clogging. Pressure measurement from WIKA monitors the vacuum of the deduster.

A particular challenge is to dry hygroscopic thermoplastics to the optimum residual humidity for processing. This is only possible using air processing with an extremely low dew point and thus a minimal absolute water content.

Temperature measuring instruments from WIKA support the energy-efficient operation of the dryers. Our level measuring instruments monitor the filling height in the drying vessel, and pressure measuring instruments secure the air supply to the blower.

As a plastics processor with over 30 of our own injection moulding machines, WIKA understands these challenges. The cooperation of our development and manufacturing has led to products which fulfil the measurement tasks of granulate preparation outstandingly.

**Deduster**



**Dryer**



**Legend – Deduster & dryer:**

- ① Heated air – Temperature
- ② Filling the vessel - Load cell
- ③ Air flow – Pressure
- ④ Dust removal – Vacuum

## Pressure

### Pressure sensors

③ ④



A-10  
O-10  
A-1200

### Pressure gauges

③ ④



111.10  
111.12  
131.11  
212.20  
611.10  
PGS25

### Pressure switches

③ ④



PSD-4  
PSD-4-ECO  
PSM02

## Temperature

### Dial thermometers

①



A50  
A52

### Resistance thermometers

①



TF35  
TF37  
TF45  
TFT35  
TR33

### Temperature switches

①



TFS35  
TFS135  
SC15

## Force

### Load cells

② ④



F3201  
F3203  
F4802  
F4818

### Bending beams/shear beams

②



F3831  
F3833

### Electronics



E1930  
E1931  
E1932



# Temperature control units

Temperature control units are frequently used in the plastics and rubber industries. In these applications, they preheat the tools to operating temperature and dissipate the heat generated during series production. This prevents overheating of the tool and damage to the product.

A plastics machine frequently runs in continuous operation (24/7). Thus, the temperature control plays an important role.

Temperature control units have an external connection to a circuit, such as in the temperature control of an injection moulding tool in the plastics industry, and they are available as immersion baths, such as those used in laboratories or for quality assurance. The designs stretch from standard series production instruments through to project-designed temperature control plants (frequently multi-circuit systems) for production processes, for which large volumes of heat are required or possibly must be removed.

## Main components:

- Vessel with heater and heat exchanger
- Recirculation pump
- Temperature controller

The versions cover cooling instruments down to  $-150\text{ °C}$  [ $-240\text{ °F}$ ], to heating systems (thermal oil heaters) up to  $+400\text{ °C}$  [ $+750\text{ °F}$ ]. As a heat transfer medium, water, glycol or thermal oils are used.

A level switch ensures that the heat transfer medium in the tank is sufficiently full and also controls the automatic refilling. If there is sufficient heat transfer fluid in the vessel, the circulation pump conveys it through the load and back to the vessel. In the tank, the measured temperature is fed through to the temperature controller. If it exceeds the set maximum value, the solenoid valve from the cooling water connection opens and cools the heat transfer medium in the tank to the set temperature. In the opposite case, the heat transfer medium is heated, usually with an electric cartridge heater.



## Legend – Temperature control unit:

- ① Level in the tank – Level
- ② Temperature in the vessel – Temperature
- ③ Temperature in the inlet line – Temperature
- ④ Pressure in the inlet line – Pressure
- ⑤ Flow measurement for the process - Flow
- ⑥ Temperature in the return line – Temperature

## Pressure

### Pressure sensors ④



A-10  
S-20  
M-10  
O-10  
A-1200

### Pressure gauges ④



111.10  
111.12  
113.53  
131.11  
213.53

### Pressure switches ④



PSD-4  
PSD-4-ECO  
PSM02

## Temperature

### Resistance thermometers ② ③ ⑥



TF35  
TF45  
TFT35  
TR10-C

### Dial thermometers ② ③ ⑥



32  
A50  
A52  
SC15

## Level

### Submersible pressure sensors ①



LS-10

### Floats ①



RLT-1000  
RLS-1000

### Optoelectronic switches ①



OLS-C01  
OLS-C02

## Flow

### Flow switches ⑤



FSD-4



# High-pressure test benches

Many machine components are subjected to an internal pressure during operation, e.g. valves and fittings, pressure accumulators, hydraulic hoses or fuel lines. The tests on and with these components are carried out during product development and later in series production for quality assurance. While one wants to determine the maximum values until destruction with testing in the laboratory, in production it is the function that is checked, e.g. the internal and external leak tightness (leakage tests).

Spindle pumps are one type of pump used in high-pressure test benches. No volume flow is generated here, but rather, the fluid is compressed. With a spindle pump, the high pressure can be set very precisely.

The comparison with the test item requires a reference such as a high-pressure gauge or a high-pressure sensor, which enables automatic logging. WIKA offers pressure measuring instruments up to 15,000 bar for electronic pressure sensors, and up to 6,000 bar for high-pressure gauges.

Industry 4.0 is also appearing in high-pressure test benches with the change from indicating measuring instruments to electronic sensors, which enable automated and reproducible tests.



## Legend – High-pressure test benches:

- ① Power pack – Pressure, temperature, level
- ② Pressure booster – Pressure

## Pressure

### Pressure switches ①



PSM-520  
PSM02  
PSM-700  
PSD-4  
PSD-4-ECO

### Pressure gauges ① ②



113.53  
213.53  
PG23HP

### Pressure sensors ① ②



A-10  
A-1200  
CPT6020  
HP-2  
IS-3  
P-30  
S-20

## Temperature

### Resistance thermometers ①



TF35  
TR10-D  
TR33

### Temperature switches ①

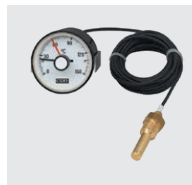

TFS35  
TFS135  
TSD-30

## Level

### Float switches and sensors ①



GLS-1000  
RLS-1000  
RLT-1000

## Accessories

### Valves



HPNV  
BV

## Calibration - For quality measurement in the test laboratory

### Digital pressure gauge



CPG1500

### Process calibrators



CPH7000  
CPT7000

### Micro calibration bath



CTB9100-165

### Hand spindle pump

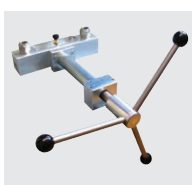

CPP1000-M

# Curing presses

Despite all the electronic aids, a car today still has only four points of contact with the road. Each of the four tyres is critical for a safe journey, and all this under the most diverse operating conditions. The extremely high quality requirements that every tyre manufacturer has for its products also apply to trucks and other transport vehicles required to carry large loads on rough ground.

In addition to these quality requirements, sustainability is becoming increasingly important. Behind this lies the improvement of energy efficiency or the increase of production efficiency, among other things, by avoiding rejects, while at the same time shortening production cycles. In order for each production step to be optimally planned and executed, precise and completely reliable measurement technology is required.

Tyre production is a rough process, especially vulcanisation in the curing press. This is where the green tyre becomes the durable tyre. Short cycles with rapid temperature rises and a sulphurous atmosphere put a load on the components of the press and, thus, also the measuring instruments.

The reliability and precision of WIKA pressure switches and pressure sensors over very long periods of use enable savings to be made in maintenance and servicing and also prevent production errors or even an outage of the production line.

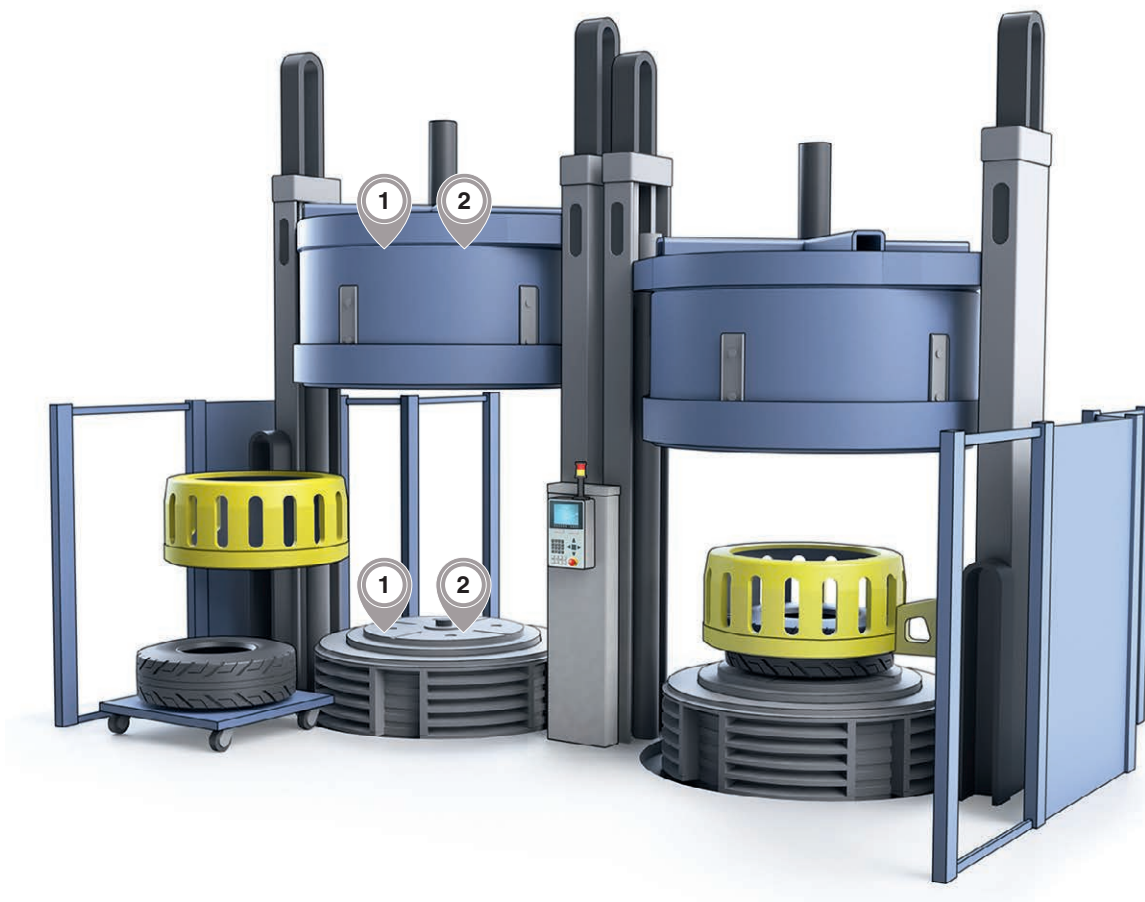

## Legend - Curing presses:

- ① Filling of the rubber bladder - Pressure
- ② Mould temperature - Temperature

## Pressure

### Pressure switches ①



MW  
PSD-4  
PSD-4-ECO

### Pressure gauges ①



213.40  
212.20  
213.53

### Pressure sensors ①



S-20

## Accessories

### Overpressure protector



910.13

## Temperature

### Resistance thermometers ②



TR53  
TR10-B  
TR10-C

### Temperature switches ②



TFS35  
TFS135  
TSD-30

# Cranes and hoists

When moving large loads, reliable monitoring ensures both operational safety (overload) and protection of operating personnel (occupational safety).

## Indoors

In factories, heavy loads are often moved by overhead cranes. For monitoring, WIKA offers both continuously measuring load pins that replace non-measuring retaining bolts, as well as tension/compression force transducers that are positioned directly in the force flow, each with a suitable overload switch. The chain hoist test set offers a quick and easy safety check of the friction clutch.

Outdoor applications are, e.g., harbour cranes or maritime applications such as cranes on supply ships or oil rigs. Our instruments are certified to DNV.

The requirements for safety controls are described in the machinery directive (2006/42/EC), e.g., overload controls or emergency stop switches. WIKA has developed the first system solution for overload protection in crane systems certified in Germany. This consists of up to eight redundant force transducers, a central control and the associated user software.

## Outdoors

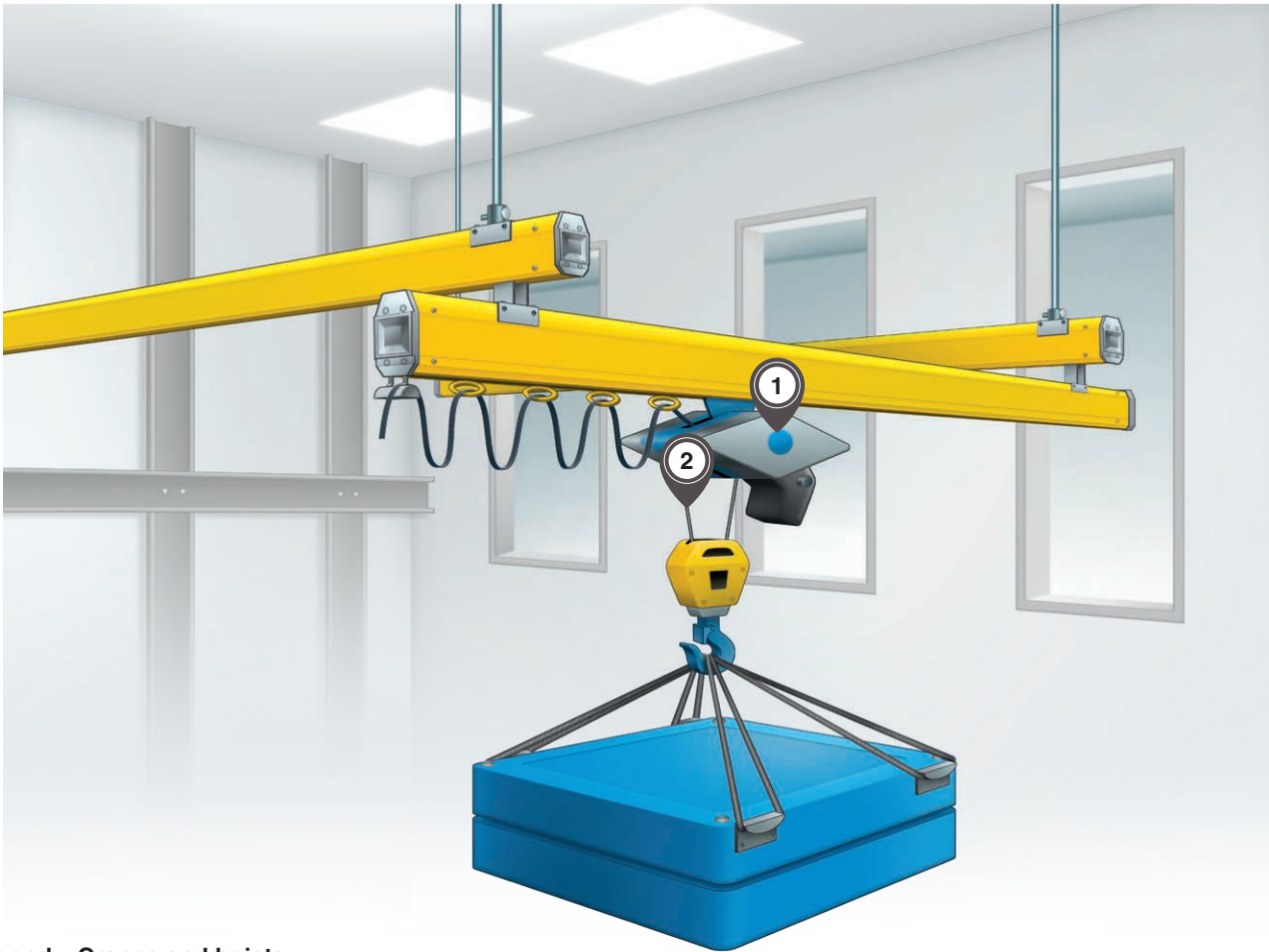

### Legend – Cranes and hoists:

- ① Load measurement – Force
- ② Friction clutch testing – Force

## Force

### Load pins

①



F5301  
F5308  
F53C1  
F53C8  
F53S8

### Compression force transducers

①



F2301  
F7301

### Special force transducers

②



F9204  
F9304

### Chain hoist test set

②



FRKPS

## Overload protection certified in accordance with EN ISO 13849-1

### Safety electronics



ELMS1

### Limit switches



EGS01  
EGS80  
ESC24

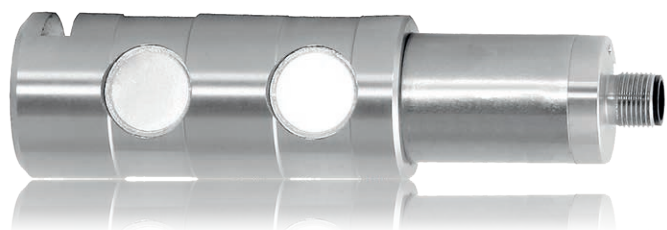



# General machine building

The close cooperation with our customers enables instruments that meet individual requirements in a very special way and reliably ensure machine functionality. This increases the performance of equipment and strengthens the competitiveness and market position of our customers.

Our developments with more than 20,000 partners in the machine-building sector have led to a globally unique product programme covering the entire range of instrumentation requirements. The pictures show a selection of further application areas for which we have already implemented specific measurement technology.

**Calibration benches**

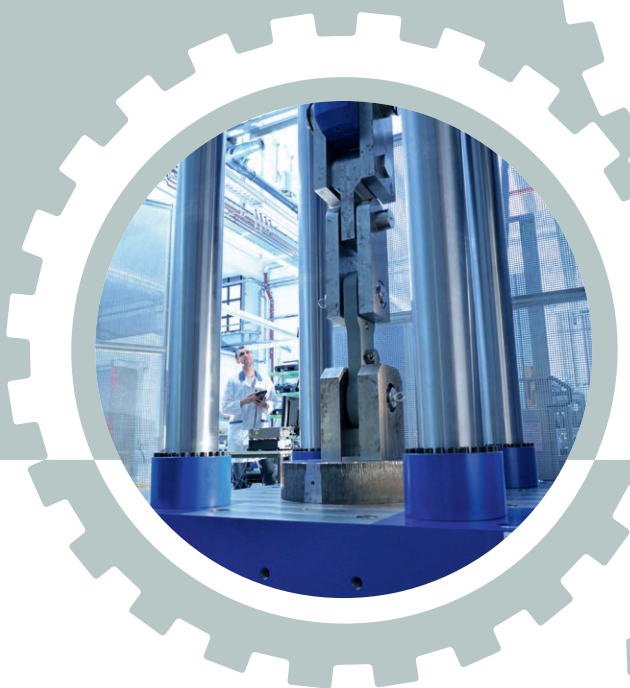

**Presses**



**Woodworking machinery**



Textile machinery

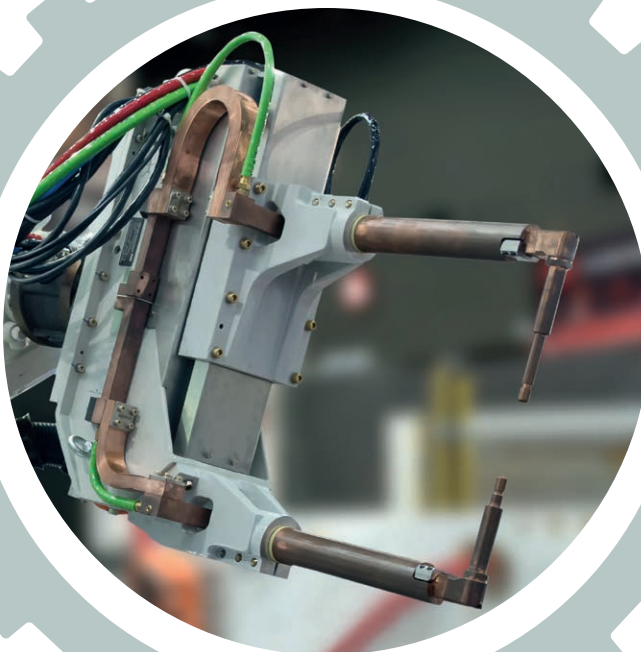

Welding tongs



Packaging machinery

# Diaphragm seals

Diaphragm seals are always used when the conditions at the point of usage deviate from the permissible specifications for the pressure measuring instrument. These are, for example:

- Too low or too high temperatures of the media
- Aggressive media
- Particle-laden media (also where there is scale formation in the hot-water systems)
- Abrasive media
- Highly viscous media

A further application is the connection of the measuring location with a remotely mounted pressure measuring instrument.

Diaphragm seal systems are delivered by WIKA as ready-to-use, filled systems. These consist of the diaphragm seal itself (the process connection), the mounting element and the pressure measuring instrument. All components are perfectly matched to one another.

The combined systems can withstand a pressure of 10 mbar up to 3,600 bar at extreme temperatures (-130 ... +400 °C) and with a wide variety of media, thus enabling accurate pressure measurements under extreme conditions.

Our programme is rounded off by test certificates and approvals for specific applications.

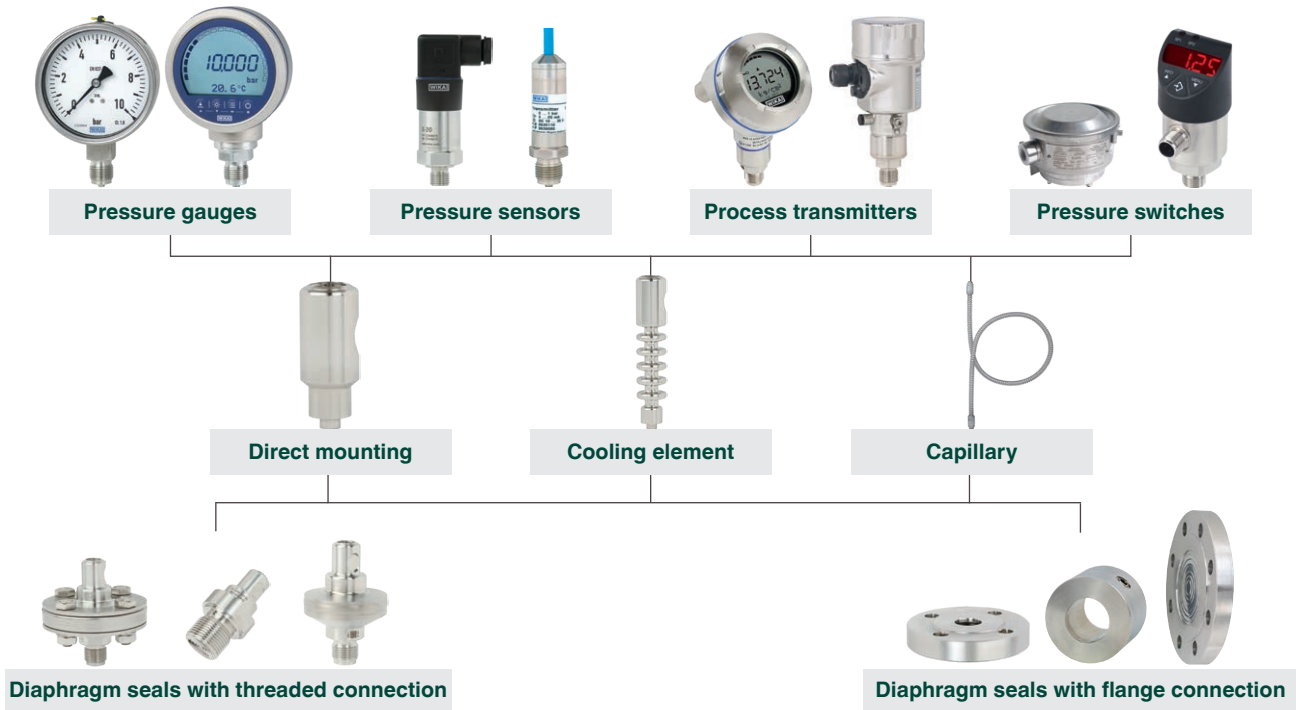

# Pressure sensor assemblies and modules

## Customer-specific electronic pressure measurement solutions

We see ourselves not only as a provider of top quality measurement technology, but also as a highly competent partner that is able to create individually designed solutions together with you. In close cooperation with you, we are ready to develop products that are tailor-made to cater for your individual needs. Create your perfect pressure sensor solution together with us. Here, the experience from a multitude of completed projects is incorporated - thus we can refer back to numerous proven solutions and components. As required, we will adapt our systems to your individual application or develop new ones.

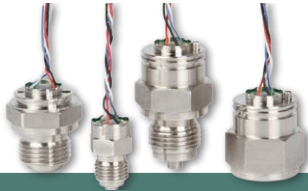

**TTF-1**

**Metal thin-film pressure sensor assembly**



**SCT-1**

**Ceramic pressure sensor element**



**SPR-2, TPR-2**

**Piezo pressure sensor element and pressure sensor assembly**



**TI-1**

**Piezo or metal thin-film pressure sensor module**



**MPR-1**

**Pressure sensor module  
Up to 25 bar gauge and absolute**



**MTF-1**

**Pressure sensor module  
Up to 1,000 bar**

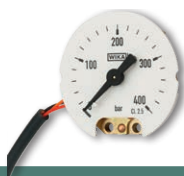

**PMT01**

**OEM pressure measuring system  
with output signal**

# Accessories



Repeater power supplies and temperature controllers



DI25

Digital indicator for panel mounting



EGS80

Digital limit switch



M12 x 1 cable

Preassembled cables

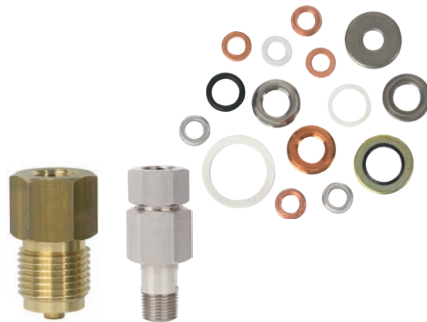

910.14, 910.17

Connectors and seals



Cooling elements



Pressure lines



910.33

Adhesive label set for red and green circular arcs



**910.16**

**Instrument mounting bracket**



**910.10, 910.11, IV10**

**Stopcocks and shut-off valves**



**IV50, IV51**

**Valve manifolds for differential pressure measuring instruments**



**BV**

**Ball valve**



**HPNV**

**High-pressure needle valve**



**CV**

**Check valve**



**B1940**

**Analogue cable amplifier**



**B6578**

**Junction box for load cells**

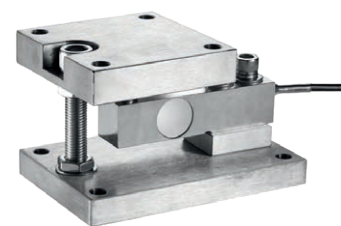

**AZK01, AZK02, AZK03**

**Mounting kit for load cells**

# Calibration instruments



**CPG1500**

**Precision digital pressure gauge**

Measuring range: -1 ... 10,000 bar  
 Accuracy (% of span): up to 0.025 % FS  
 Special feature:
 

- Integrated data logger
- WIKA-Cal compatible
- Data transfer via WIKA-Wireless
- Password protection possible
- Robust case IP65

Data sheet: CT 10.51



App „myWIKA device“  
 Play Store



**CPH6300**

**Hand-held pressure indicator**

Measuring range: 0 ... 0.025 to 0 ... 1,000 bar  
 Accuracy: 0.2 %, 0.1 % (optional)  
 Special feature:
 

- Robust and waterproof case with IP65, IP67
- Integrated data logger
- Differential pressure measurement (optional)

Data sheet: CT 12.01



**CPH7000**

**Portable process calibrator**

Measuring range: -1 ... 25 bar (-1 ... 10,000 bar with CPT7000)  
 Accuracy: 0.025 % FS  
 Special feature:
 

- Integrated pressure generation
- Measurement of pressure, temperature, current, voltage, ambient conditions
- Supply of pressure, current and voltage
- Calibration function/data logger/switch test
- Intrinsically safe (option)

Data sheet: CT 15.51



**CPP30**

**Pneumatic hand test pump**

Measuring range: -950 mbar ... +35 bar  
 Medium: Ambient air  
 Special feature:
 

- Pressure and vacuum generation switchable
- Compact dimensions

Data sheet: CT 91.06

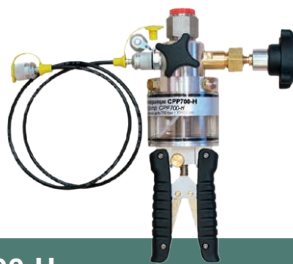

**CPP700-H**

**Hydraulic hand test pump**

Measuring range: 0 ... 700 or 0 ... 1,000 bar  
 Medium: Oil or water  
 Special feature:
 

- Integrated medium reservoir
- Ergonomic handling

Data sheet: CT 91.07



**CPG-KITH, CPG-KITP**

**Hydraulic or pneumatic service kit**

- Simple testing and adjustment of pressure measuring instruments
- Kit consists of a CPG1500 reference instrument and a CPP-700H hand pump (hydraulic  $P_{max}$  700 bar) or CPP-30 (pneumatic  $P_{max}$  30 bar)





DG-10

**Precision digital pressure gauge**

Measuring range: ■ 0 ... 5 to 0 ... 700 bar  
 ■ -1 ... +5 to -1 ... +10 bar

Accuracy (% of span): ≤ 0.5 % FS ±1 digit

Special feature: ■ Robust stainless steel case, nominal size 80 mm  
 ■ Battery operation (2 x 1.5 V AA cell)  
 ■ Option: Rotatable instrument head, backlighting

Data sheet: PE 81.66

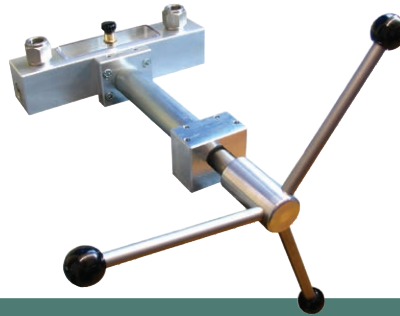

CPP1000-M

**Hydraulic hand spindle pump**

Measuring range: 0 ... 1,000 bar

Medium: Oil or water

Special feature: ■ Smooth-running, internally operating precision spindle  
 ■ Compact dimensions

Data sheet: CT 91.05



CTB9100

**Micro calibration bath**

Measuring range: -35 ... +255 °C

Accuracy: ±0.2 ... 0.3 K

Stability: ±0.05 K

Special feature: ■ Short heating and cooling times  
 ■ Easy to use

Data sheet: CT 46.30



CTB9100

**Micro calibration bath**

Measuring range: -35 ... +255 °C

Accuracy (% of span): ±0.2 ... 0.3 K

Special feature: ■ Short heating and cooling times  
 ■ Easy to use

Data sheet: CT 46.30



CTR3000

**Multi-functional precision thermometer**

Measuring range: -210 ... +1,820 °C

Accuracy (% of span): ■ ±0.005 K (4-wire)  
 ■ ±0.03 K (3-wire)  
 ■ ±0.004 % + 2 µV for thermocouples

Special feature: ■ Versatile applications by measuring thermocouples and resistance thermometers  
 ■ Logger and scan functions  
 ■ Up to 44 channels possible

Data sheet: CT 60.15



CTH6500

**Hand-held thermometer Precision version**

Measuring range: -200 ... +1,500 °C

Accuracy (% of span): ■ 0.03 ... 0.2 K

Special feature: ■ Integrated data logger (optional)  
 ■ Ex version: Model CTH6510

Data sheet: CT 55.10





# Calibration service

Our calibration laboratories have been calibrated for pressure and temperature for over 30 years.

Since 2014, our calibration laboratory has also been accredited for the electrical measurands DC current, DC voltage and DC resistance. Since 2020, our calibration laboratory has also been accredited for force. Recently, factory calibration for length measuring instruments has been expanding our portfolio.

- ISO 9001-certified
- DAKKS-accredited (in accordance with DIN EN ISO/IEC 17025)
- Cooperation in the DKD/DAkKS working groups
- Over 60 years of experience in pressure and temperature measurement
- Highly qualified, individually trained personnel
- Latest reference instruments with the highest accuracy

## Manufacturer-independent calibration - fast and precise for ...

### Pressure

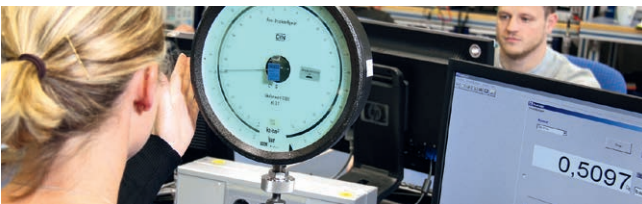

- -1 bar ... +10,000 bar
- Calibration using working standards (precise electrical pressure measuring instruments) or high-accuracy reference standards (pressure balances)
- With an accuracy of 0.003 % ... 0.01 % of reading
- In accordance with the directives DIN EN 837, DKD-R 6-1 or EURAMET cg-3

### Temperature



- -196 ... +1,200 °C  
(to +1,600 °C possible with factory calibration)
- Comparative calibration in calibration baths and tube furnaces with an accuracy of down to 1.5 mK
- Calibration at fixed points of ITS-90 with the smallest possible measurement uncertainties
  - Triple point of mercury (-38.8344 °C)
  - Triple point of water (0.01 °C)
  - Melting point of gallium (29.7646 °C)
  - Freezing point of tin (231.928 °C)
  - Freezing point of zinc (419.527 °C)
  - Freezing point of aluminium (660.323 °C)
- In accordance with the appropriate DKD guideline

### Current, voltage, resistance



- DC current from 0 mA ... 100 mA
- DC voltage from 0 V ... 100 V
- DC resistance from 0 Ω ... 10 kΩ
- In accordance with the directives VDI/VDE/DGQ/DKD 2622



## Manufacturer-independent calibration - fast and precise for ...

### Force



- 1 kN ... 200 kN  
(500 N ... 6 MN possible with 3.1 inspection certificate)
- With a system accuracy of 0.5 % in tension and compression force direction
- In accordance with directive DIN EN 10204
- DAkkS-accredited (in accordance with DIN EN ISO/IEC 17025)

### Length



- Factory calibration
- Replacement of the measuring device if required
- Calibration of special-purpose gauges in accordance with customer drawings
- Calibratable measuring devices
  - Callipers to 800 mm
  - Testing pins to 100 mm
  - Ring gauges and plug gauges to 150 mm
  - Tapered thread gauges to 150 mm
  - Gauge blocks to 170 mm  
(also possible as a set)
  - others on request

## Seminars and trainings



Are you interested in a product, calibration or software training? As an individual or as a group; on-site at your company or at WIKA? Then speak to us. Together with you, our certified trainers can design precisely the course contents that you need for your requirements.

We look forward to seeing you!

**Service team**  
 Tel. +49 9372 132-5049  
 CTServiceTeam@wika.com







Visit us on our website and on our social media channels.



**WIKA website**



Find out about our wide range of measurement technology and services, or market sectors. Download 3D drawings, technical documents or informative brochures. And please register for our free newsletter!



**WIKA online shop**

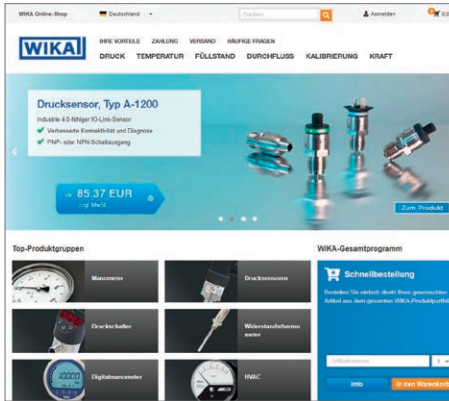

Simple, quick and secure: Directly select the right product for you from our standard portfolio. Or adapt the instrument you want exactly to your requirements with our configurator.



**WIKA blog**

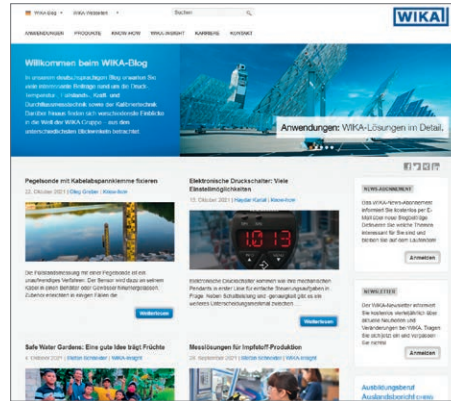

In our blog, you can expect many interesting articles on the theme of measurement technology. Furthermore, there are various insights into the world of the WIKA Group.



**WIKA on LinkedIn**

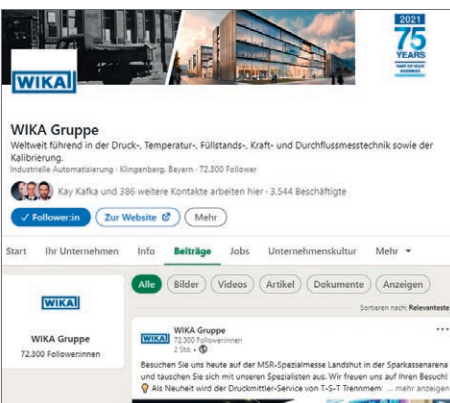

Follow us on LinkedIn. Don't just follow our news on products and applications, but also on important events within the WIKA Group.



**WIKA YouTube channel**

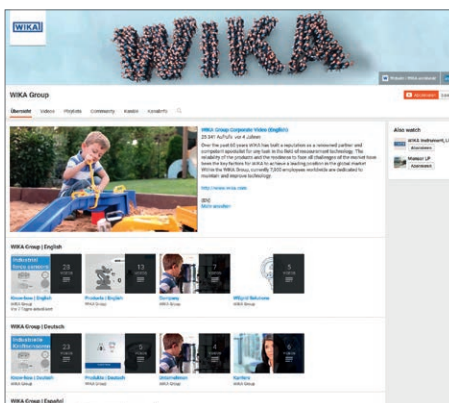

We are also happy to welcome you to our YouTube channel. Here we don't just promote our company, but also present complex technical contents, explained in a simple and understandable way.

# WIKA worldwide

## Europe

### Austria

WIKA Messgerätevertrieb  
Ursula Wiegand GmbH & Co. KG  
Tel. +43 1 8691631  
info@wika.at / www.wika.at

### Benelux

WIKA Benelux  
Tel. +31 475 535500  
info@wika.nl / www.wika.nl

### Bulgaria

WIKA Bulgaria EOOD  
Tel. +359 2 82138-10  
info@wika.bg / www.wika.bg

### Croatia

WIKA Croatia d.o.o.  
Tel. +385 1 6531-034  
info@wika.hr / www.wika.hr

### Denmark

WIKA Danmark A/S  
Tel. +45 4581 9600  
info@wika.as / www.wika.as

### Finland

WIKA Finland Oy  
Tel. +358 9 682492-0  
info@wika.fi / www.wika.fi

### France

WIKA Instruments s.a.r.l.  
Tel. +33 1 787049-46  
info@wika.fr / www.wika.fr

### Germany

WIKA Alexander Wiegand SE & Co. KG  
Tel. +49 9372 132-0  
info@wika.de / www.wika.de

### Italy

WIKA Italia S.r.l. & C. S.a.s.  
Tel. +39 02 93861-1  
info@wika.it / www.wika.it

### Poland

WIKA Polska spółka z ograniczoną  
odpowiedzialnością sp. k.  
Tel. +48 54 230110-0  
info@wikapolska.pl  
www.wikapolska.pl

### Romania

WIKA Instruments Romania S.R.L.  
Tel. +40 21 4048327  
info@wika.ro / www.wika.ro

### Russia

AO "WIKA MERA"  
Tel. +7 495-648018-0  
info@wika.ru / www.wika.ru

### Serbia

WIKA Merna Tehnika d.o.o.  
Tel. +381 11 2763722  
info@wika.rs / www.wika.rs

### Spain

Instrumentos WIKA S.A.U.  
Tel. +34 933 9386-30  
info@wika.es / www.wika.es

### Switzerland

WIKA Schweiz AG  
Tel. +41 41 91972-72  
info@wika.ch / www.wika.ch

### Türkiye

WIKA Instruments  
Endüstriyel Ölçüm Cihazları Tic. Ltd. Şti.  
Tel. +90 216 41590-66  
info@wika.com.tr  
www.wika.com.tr

### Ukraine

TOV WIKA Prylad  
Tel. +38 044 496 83 80  
info@wika.ua / www.wika.ua

### United Kingdom

WIKA Instruments Ltd  
Tel. +44 1737 644-008  
info@wika.co.uk / www.wika.co.uk

## North America

### Canada

WIKA Instruments Ltd.  
Tel. +1 780 4637035  
info@wika.ca / www.wika.ca

### USA

WIKA Instrument, LP  
Tel. +1 770 5138200  
info@wika.com / www.wika.us

### Gayesco-WIKA USA, LP

Tel. +1 512 3964200  
info@wikahouston.com  
www.wika.us

### Mensor Corporation

Tel. +1 512 3964200  
sales@mensor.com  
www.mensor.com

## Latin America

### Argentina

WIKA Argentina S.A.  
Tel. +54 11 5442 0000  
ventas@wika.com.ar  
www.wika.com.ar

### Brazil

WIKA do Brasil Ind. e Com. Ltda.  
Tel. +55 15 3459-9700  
vendas@wika.com.br  
www.wika.com.br

### Chile

WIKA Chile S.p.A.  
Tel. +56 9 4279 0308  
info@wika.cl / www.wika.cl

### Colombia

Instrumentos WIKA Colombia S.A.S.  
Tel. +57 601 7021347  
info@wika.co / www.wika.co

### Mexico

Instrumentos WIKA Mexico S.A. de C.V.  
Tel. +52 55 50205300  
ventas@wika.com / www.wika.mx

## Asia

### China

WIKA Instrumentation Suzhou Co., Ltd.  
Tel. +86 512 6878 8000  
info@wika.cn / www.wika.com.cn

### India

WIKA Instruments India Pvt. Ltd.  
Tel. +1800-123-101010  
info@wika.com.in / www.wika.com.in

### Japan

WIKA Japan K. K.  
Tel. +81 3 5439-6673  
info@wika.co.jp / www.wika.co.jp

### Kazakhstan

TOO WIKA Kazakhstan  
Tel. +7 727 225 9444  
info@wika.kz / www.wika.kz

### Korea

WIKA Korea Ltd.  
Tel. +82 2 869-0505  
info@wika.co.kr / www.wika.co.kr

### Malaysia

WIKA Instrumentation (M) Sdn. Bhd.  
Tel. +60 3 5590 6666  
info@wika.my / www.wika.my

### Philippines

WIKA Instruments Philippines Inc.  
Tel. +63 2 234-1270  
info@wika.ph / www.wika.ph

### Singapore

WIKA Instrumentation Pte. Ltd.  
Tel. +65 6844 5506  
info@wika.sg / www.wika.sg

### Taiwan

WIKA Instrumentation Taiwan Ltd.  
Tel. +886 3 420 6052  
info@wika.tw / www.wika.tw

### Thailand

WIKA Instrumentation Corporation  
(Thailand) Co., Ltd.  
Tel. +66 2 326 6876  
info@wika.co.th / www.wika.co.th

### Uzbekistan

WIKA Instrumentation FE LLC  
Tel. +998 71 205 84 30  
info@wika.uz / www.wika.uz

## Africa/Middle East

### Botswana

WIKA Instruments Botswana (Pty.) Ltd.  
Tel. +267 3110013  
info@wika.co.bw / wika.co.bw

### Egypt

WIKA Near East Ltd.  
Tel. +20 2 240 13130  
info@wika.com.eg / www.wika.com.eg

### Namibia

WIKA Instruments Namibia Pty Ltd.  
Tel. +26 4 61238811  
info@wika.com.na / www.wika.com.na

### Nigeria

WIKA WEST AFRICA LIMITED  
Tel. +234 17130019  
info@wika.com.ng / www.wika.ng

### Saudi Arabia

WIKA Saudi Arabia LLC  
Tel. +966 53 555 0874  
info@wika.sa / www.wika.sa

### South Africa

WIKA Instruments Pty. Ltd.  
Tel. +27 11 62100-00  
sales@wika.co.za / www.wika.co.za

### United Arab Emirates

WIKA Middle East FZE  
Tel. +971 4 883-9090  
info@wika.ae / www.wika.ae

## Australia

### Australia

WIKA Australia Pty. Ltd.  
Tel. +61 2 88455222  
sales@wika.com.au / www.wika.com.au

### New Zealand

WIKA Instruments Limited  
Tel. +64 9 8479020  
info@wika.co.nz / www.wika.co.nz

**WIKA Alexander Wiegand SE & Co. KG**  
Alexander-Wiegand-Straße 30 | 63911 Klingenberg | Germany  
Tel. +49 9372 132-0 | info@wika.de | www.wika.de

12891704 04/2023 EN



You can find further  
information here!



**Smart in sensing**

[www.wika.com](http://www.wika.com)